

8ports Remote I/O Controller

CIE-M10 User Manual

Version 3.2

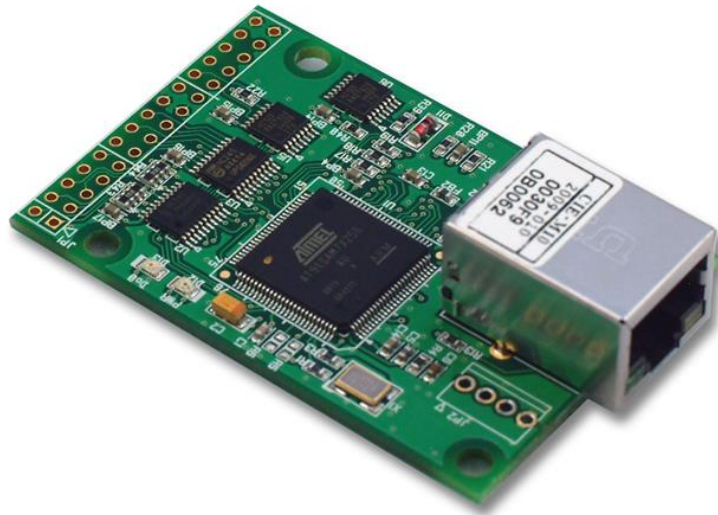

Sollae Systems Co., Ltd.

<http://www.ezTCP.com>



This symbol, found on your product or on its packaging, indicates that this product should not be treated as household waste when you wish to dispose of it. Instead, it should be handed over to an applicable collection point for the recycling of electrical and electronic equipment. By ensuring this product is disposed of correctly, you will help prevent potential negative consequences to the environment and human health, which could otherwise be caused by inappropriate disposal of this product. The recycling of materials will help to conserve natural resources. For more detailed information about the recycling of this product, please contact your local city office, household waste disposal service or the retail store where you purchased this product.

※ This equipment obtained certification by using 1.5M serial cable.

Contents

Contents	- 2 -
1 Introduction	- 6 -
1.1 Introduction	- 6 -
1.2 Features	- 6 -
1.3 Application Examples	- 7 -
1.4 Component	- 8 -
1.5 Specification	- 9 -
1.5.1 H/W specification	- 9 -
1.5.2 S/W specification	- 9 -
1.6 Interface	- 10 -
1.6.1 Dimension	- 10 -
1.6.2 Pin assignment	- 11 -
1.6.3 Digital Input Ports	- 12 -
1.6.4 Analog Input Port	- 13 -
1.6.5 Digital Output Ports	- 13 -
1.6.6 Ethernet Interface	- 14 -
1.6.7 RS232 Port (DB9M)	- 14 -
1.6.8 System LED	- 15 -
2 Installation and Test	- 16 -
2.1 Installation	- 16 -
2.1.1 Setting Network Aera	- 16 -
2.2 Test operation	- 18 -
2.2.1 Modbus/TCP Test	- 18 -
2.2.2 HTTP Test with a WEB browser	- 20 -
3 Configuration	- 21 -
3.1 Configuration with ezManager	- 21 -
3.1.1 Configuration via LAN	- 21 -
3.1.2 Configuration via Serial	- 22 -
3.2 AT command	- 23 -
4 Operation Modes	- 24 -
4.1 What is the Operation Mode?	- 24 -
4.2 How to change the mode to another	- 24 -
4.3 Comparison of the each mode	- 25 -

4.4	Normal Mode	- 25 -
4.5	Serial Configuration mode	- 26 -
4.5.1	<i>Configuring Parameters</i>	- 26 -
4.5.2	<i>Revoking Security Options</i>	- 26 -
4.6	ISP mode.....	- 26 -
4.6.1	<i>Upgrading Firmware</i>	- 26 -
4.6.2	<i>Upgrading HTML</i>	- 26 -
4.6.3	<i>Revoking Security Options</i>	- 26 -
5	Methods for I/O control	- 27 -
5.1	Modbus/TCP.....	- 27 -
5.1.1	<i>.Related Parameters</i>	- 27 -
5.1.2	<i>Modbus/TCP Slave Mode</i>	- 28 -
5.1.3	<i>Modbus/TCP Master Mode</i>	- 28 -
5.1.4	<i>TCP Connection Modes</i>	- 29 -
5.1.5	<i>Initial State</i>	- 29 -
5.1.6	<i>Write Pulse</i>	- 29 -
5.2	Serialized Modbus/TCP	- 29 -
5.3	Macro Mode.....	- 30 -
5.3.1	<i>Operator</i>	- 30 -
5.3.2	<i>Operand</i>	- 30 -
5.3.3	<i>An Example of Equations</i>	- 31 -
5.4	Web (HTTP).....	- 32 -
5.4.1	<i>Changing the Web(HTTP) port</i>	- 32 -
5.4.2	<i>Uploading Users' Web Page</i>	- 33 -
6	Communication Modes	- 34 -
6.1	TCP Server	- 34 -
6.1.1	<i>Key parameters</i>	- 34 -
6.1.2	<i>An Example</i>	- 35 -
6.2	TCP Client	- 36 -
6.2.1	<i>Key parameters</i>	- 36 -
6.2.2	<i>An Example</i>	- 37 -
6.3	AT Command	- 39 -
6.3.1	<i>Key parameters</i>	- 39 -
6.3.2	<i>Examples</i>	- 40 -
6.4	UDP	- 42 -
6.4.1	<i>Key parameters</i>	- 42 -
6.4.2	<i>Examples</i>	- 43 -

- 7 System Management..... - 45 -**
 - 7.1 Upgrading Firmware..... - 45 -
 - 7.1.1 Firmware..... - 45 -
 - 7.1.2 Processes..... - 45 -
 - 7.2 Changing Webpage..... - 47 -
 - 7.2.1 Webpage..... - 47 -
 - 7.2.2 Processes..... - 47 -
 - 7.3 Status Monitoring..... - 50 -
 - 7.3.1 Using TELNET..... - 50 -
 - 7.3.2 Using ezManager..... - 52 -
- 8 Additional Functions..... - 54 -**
 - 8.1 Security..... - 54 -
 - 8.1.1 Restriction of Access (ezTCP Firewall)..... - 54 -
 - 8.1.2 Setting Password..... - 54 -
 - 8.2 Option Tab Functions..... - 55 -
 - 8.2.1 Notify IP Change..... - 55 -
 - 8.2.2 Sending MAC Address..... - 56 -
 - 8.2.3 Debugging Message..... - 56 -
 - 8.3 Serial Port Tab Functions..... - 58 -
 - 8.3.1 TELNET COM port Control Option (RFC 2217) - ①..... - 58 -
 - 8.3.2 Disable TCP Transmission Delay - ②..... - 58 -
 - 8.3.3 Data Frame Interval - ③..... - 58 -
 - 8.3.4 TX interval - ④..... - 59 -
 - 8.3.5 TCP Server / Client mode - ⑤..... - 59 -
 - 8.3.6 Separator - ⑥..... - 59 -
 - 8.4 I/O Port Tab Functions..... - 60 -
 - 8.4.1 Notify Input Port Change..... - 60 -
 - 8.4.2 Valid Time..... - 60 -
 - 8.4.3 Delay..... - 60 -
- 9 Self-Test in Trouble - 61 -**
 - 9.1 Searching problem with ezManager..... - 61 -
 - 9.2 Connection Problem over Modbus/TCP..... - 62 -
 - 9.3 Communication Problem over Modbus/TCP..... - 63 -
- 10 Related material..... - 64 -**
 - 10.1 Technical Documents..... - 64 -
 - 10.2 Smart phone application..... - 64 -

11	Technical Support and Warranty	- 65 -
11.1	Technical Support	- 65 -
11.2	Warranty.....	- 65 -
11.2.1	<i>Refund</i>	- 65 -
11.2.2	<i>Free Repair Services</i>	- 65 -
11.2.3	<i>Charged Repair Services</i>	- 65 -
12	Precaution and Exemption from Liability	- 66 -
12.1	Precaution.....	- 66 -
12.2	Exemption from Liability.....	- 67 -
12.2.1	<i>English version</i>	- 67 -
12.2.2	<i>French version</i>	- 67 -
13	Revision History	- 70 -

1 Introduction

1.1 Introduction

In the era of Ubiquitous Environments, many kinds of systems which use sensors like temperature, humidity or pressure and controlling the power of remote devices have been developing. CIE-M10 monitors those sensors and controls the remote devices. It detects digital inputs from the sensor's outputs and controls the relay outputs. HTTP, Modbus/TCP, serialized Modbus/TCP and Macro mode can be used for these functions. CIE-M10 can be used in another way because it equipped operation as a serial device server.

1.2 Features

- Remote I/O controller
- Module type with a built-in RJ45 connector for Ethernet interface
- 8 Digital Input Ports (3.3V CMOS)
- 8 Digital Output Ports (3.3V CMOS)
- 1 x Analog Input Port (10 bits resolution ADC)
- Supports Modbus/TCP and HTTP
- Stored Web server for simple management (custom web page)
- Supports serialized Modbus/TCP
- MACRO (stand-alone operation supports simple logical expressions)
- Stable embedded TCP/IP stack
- easy configuration program (ezManager)

1.3 Application Examples

- Remote I/O device server

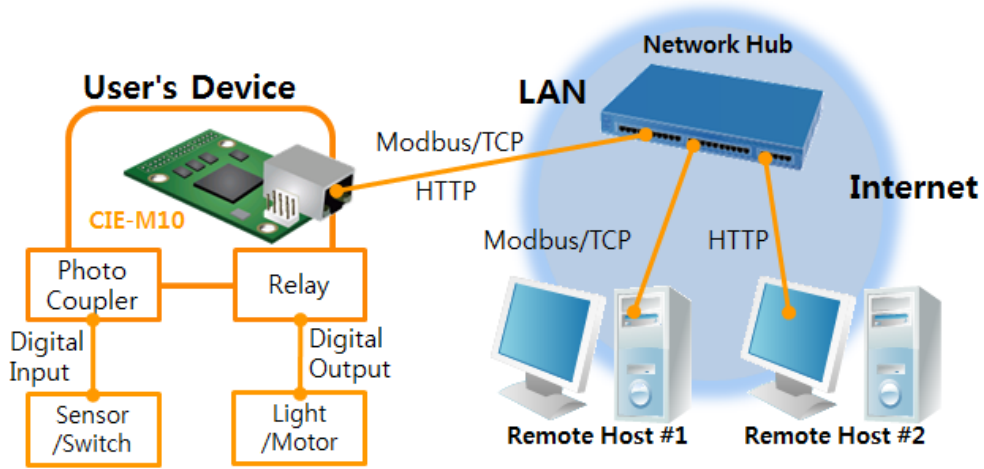

Figure 1-1 remote I/O device server

- Serialized Modbus/TCP

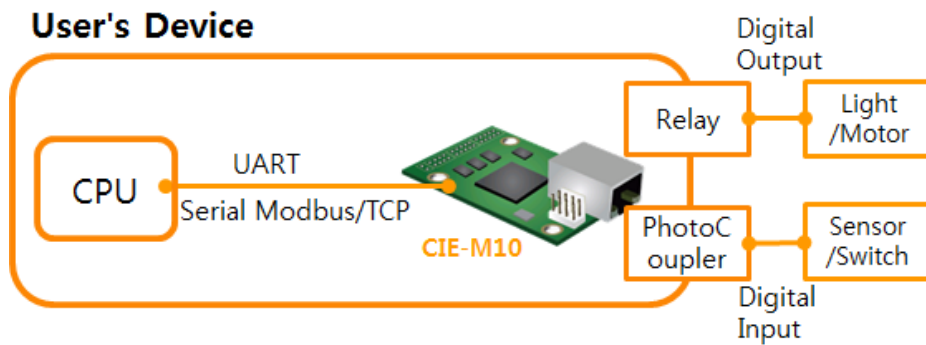

Figure 1-2 serialized Modbus/TCP

- Internet Switch

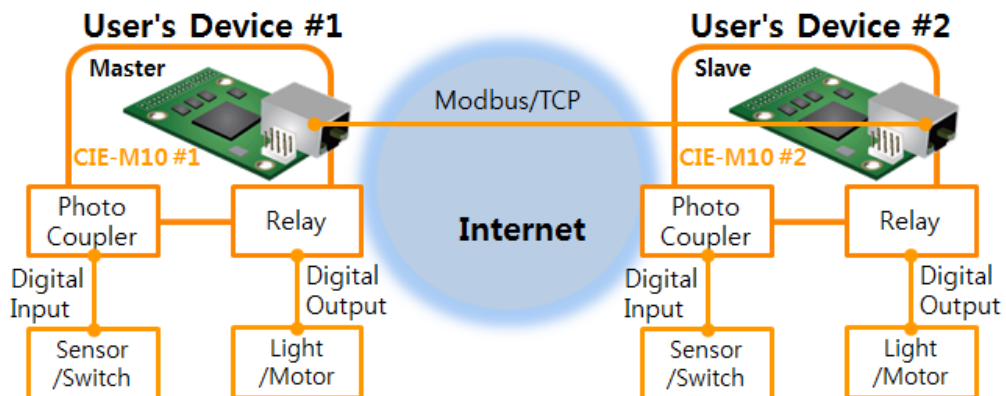

Figure 1-3 internet switch

- Macro mode

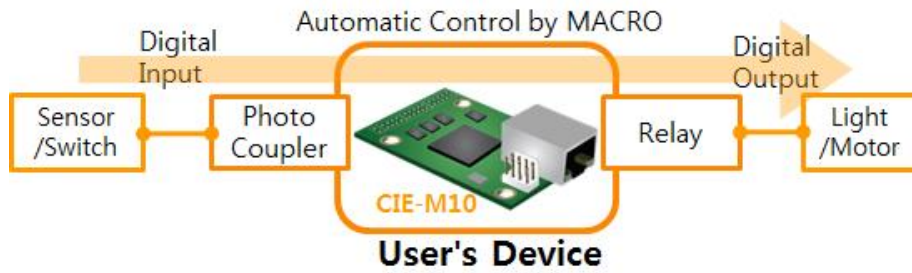

Figure 1-4 macro mode

- Serial Switch

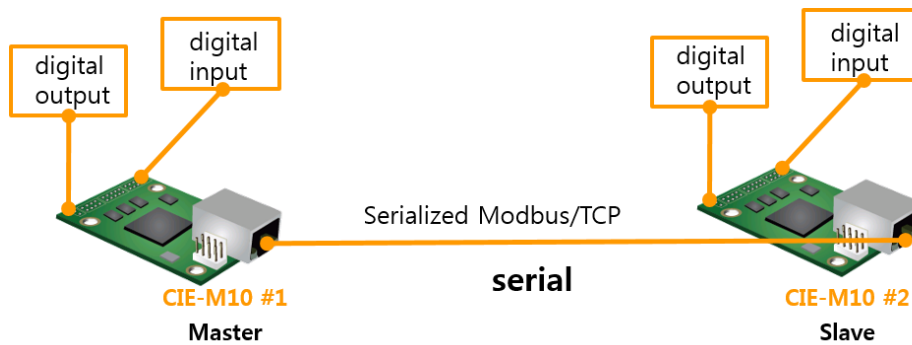

Figure 1-5 serial switch

- Serial Device Server

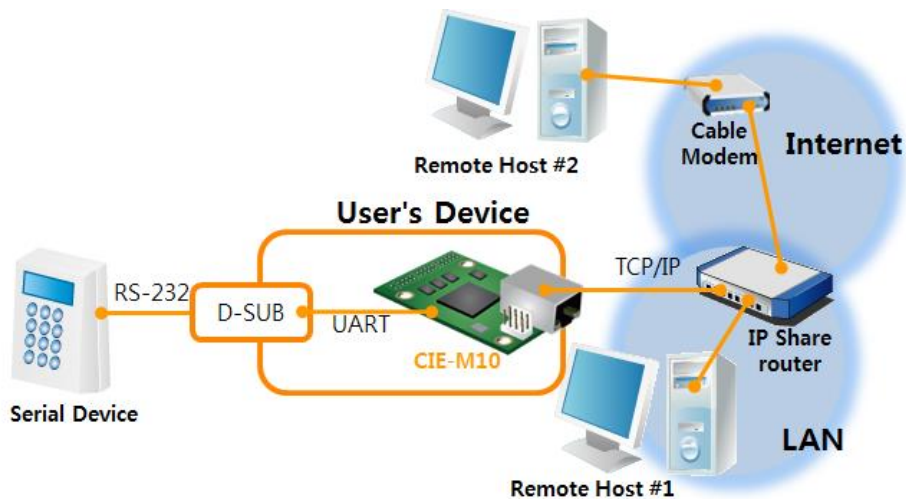

Figure 1-6 serial device server

1.4 Component

- CIE-M10

1.5 Specification

1.5.1 H/W specification

Power	Input Power	3.3V (±10%)
	Current Consumption	190mA typical
Size	64.4mm x 40mm x 17mm	
Weight	Approximately 17g	
Interfaces	Digital Input	8 digital input ports (3.3V CMOS logic level)
	Analog Input	1 ADC port (10-bit resolution)
	Digital Output	8 digital output ports (3.3V CMOS logic level)
	Serial Port	1 × UART (300~230,400 bps), RTS/CTS Flow Control, 3.3V CMOS logic level
	Ethernet	RJ45
Network	Ethernet 10Base-T or 100Base-TX (Auto-Sensing) Auto MDI/MDIX(Cable Auto-sensing)	
Temperature	Operate: 0 ~ 70°C / Storage: -40 ~ 85°C	
Environment	Follows Europe RoHS Directive	

Table 1-1 H/W specification

1.5.2 S/W specification

Protocol	TCP, UDP, IP, ICMP, ARP, DHCP, DNS lookup, DDNS, Telnet COM Port Control Option(RFC2217), Modbus/TCP, HTTP	
Diagnose	Online Debugging Function	
Operation mode	Normal	Normal communication mode
	ISP	F/W upgrade
	Serial Configuration	Configuration with the RS232 port
Communication Mode	I/O server	Modbus/TCP – Slave/Master, Passive/Active Web Browser(HTTP), Macro(Stand-alone), Serialized Modbus/TCP
	Serial devices server	TCP Server/Client, AT emulation, UDP
Programs	ezManager	Configuration program via LAN
	ModMap	Modbus/TCP Application for Windows

Table 1-2 S/W specification

1.6 Interface

1.6.1 Dimension

- Top view

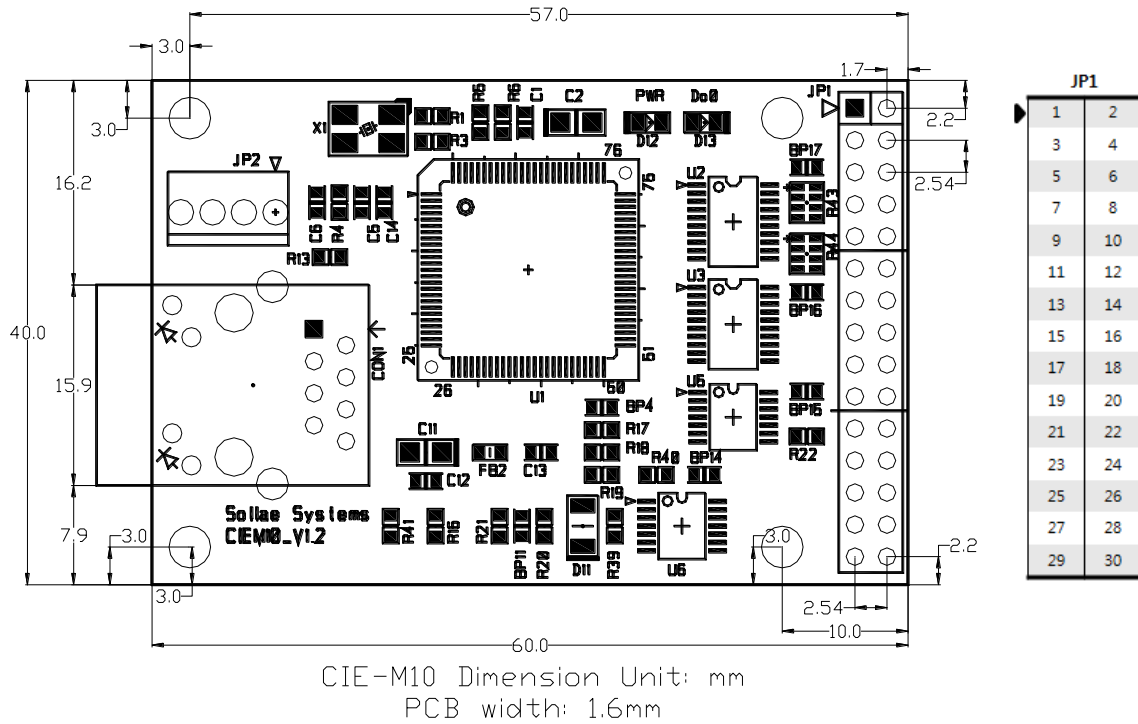

Figure 1-7 Top view

- Front and Side view

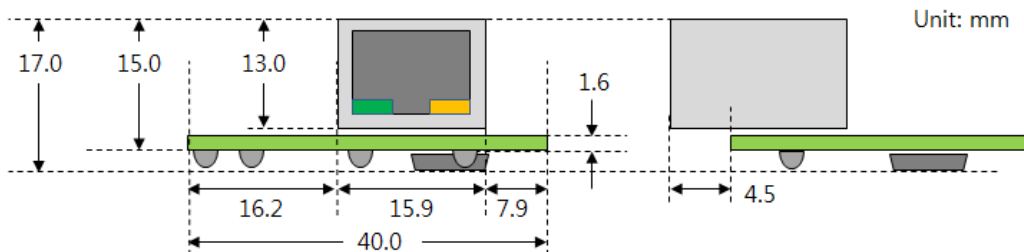

Figure 1-8 Front and Side view

☞ According to conditions of soldering components, the real dimensions might be differed with the above figure. Thus, we recommend giving some extra spaces about 1 ~ 2 mm.

1.6.2 Pin assignment

- JP1

JP1 is a user interface which is not populated by any connectors to be connected to user device with user's connector. The pitch is 2.54mm.

Pin #	Name	Description	I/O	Note
1 ~ 8	DI0 ~ DI7	Digital Input Port #0 ~ 7	In	Min V_{IL} = -0.3V Max V_{IL} = 0.8V Min V_{IH} = 2.0V Max V_{IH} = 5.5V
9 ~ 16	DO0 ~ DO7	Digital Output Port #0 ~ 7	Out	Min V_{OH} = 2.9V, Max V_{OL} = 0.4V
17	GND	Ground	—	
18	GND	Ground	—	
19	ADVREF	ADC VCC Reference (Input Voltage Range: 2.6V ~ 3.3V)	In	
20	ADC_IN0	Analog Input Port 0 (Input Voltage Range: 0V~ADVREF)	In	10-bit ADC Conversion Time: 2.33 μ s
21	RXD	Receive Data	In	
22	CTS	Clear To Send	In	
23	TXD	Transmit Data	Out	
24	RTS	Request To Send	Out	
25	RESET-	Reset (Please set this value to 200us or higher values for correct operation, Active Low)	In	
26	ISP-	ISP Mode: Low when it boots up (Internally pulled-up, Active Low)	In	
27	VCC	Power input (DC 3.3V)	—	
28	VCC	Power input (DC 3.3V)	—	
29	GND	Ground	—	
30	GND	Ground	—	

Table 1-3 JP1 pin assignment

1.6.3 Digital Input Ports

CIE-M10's digital input ports can be applied variously with circuit configuration – for example: Wet contact and Dry contact.

- Wet contact (voltage input)

This circuit gets voltage from the two input lines and convert it into logical levels (0 and 1). Then, it uses the value as a digital input. The following is a circuit example with a photo-coupler which isolates circuits electrically.

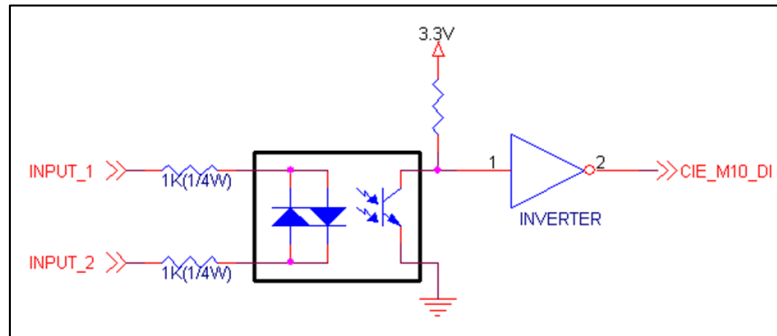

Figure 1-9 a circuit of the input port

The [INPUT 1] and [INPUT 2] ports are user interface port. The working voltage is concluded by the photo-coupler and resistors.

- Dry contact (switch input)

This type needs an additional DC power source and the power source should be isolated from the main DC power source of CIE-M10. In the figure below, input ports need just a switch as the input.

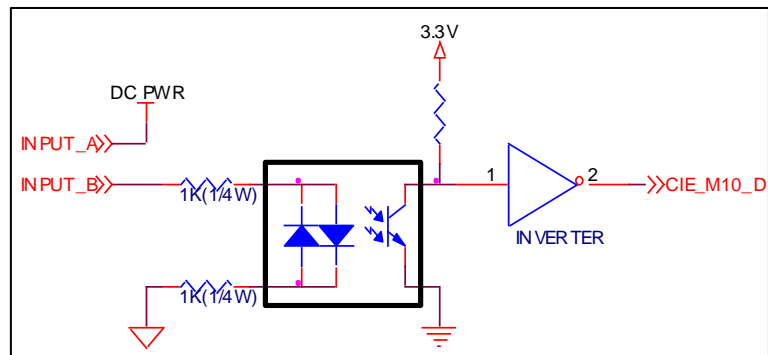

Figure 1-10 a circuit of the output port

1.6.4 Analog Input Port

There is an analog input port in CIE-M10. This port is connected to 10 bits ADC (Analog to Digital Converter). User should input 2.6V~3.3V to the ADVREF for reference voltage of the ADC. ADC_IN0 port is for user's analog sensors, its input voltage should be between 0V ~ ADVREF. The ADC converts the input voltage of the ADC_IN0 (0V~ADVREF) to 0~1023 digital value.

User can read this value through Modbus/TCP and HTTP. User can read the ADC value from the address of (Digital Input Port Address + 4) via Modbus/TCP. When user read the ADC value via a web browser, user can read this value with \$a0 variable.

☞ **All the input ports are only for the monitoring devices.**

1.6.5 Digital Output Ports

The digital output ports can be interfaced with relays or SSR(Solid-State Relay). The following is an example to interface to relays.

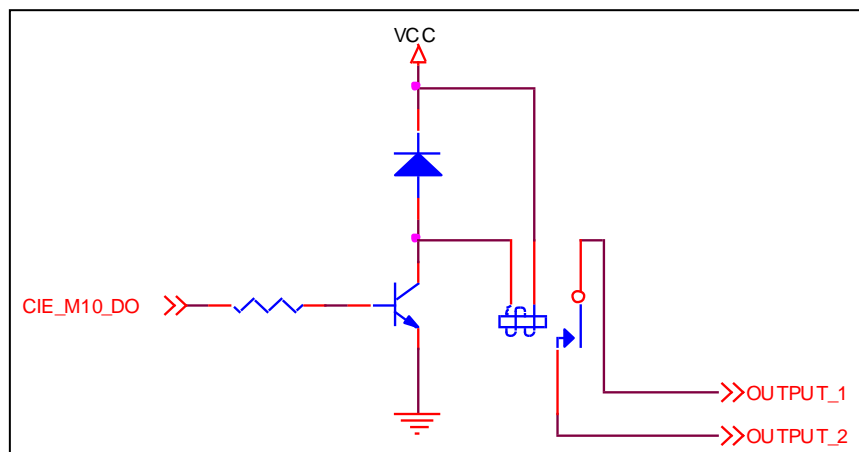

Figure 1-11 a circuit of the output port

1.6.6 Ethernet Interface

An RJ45 connector is for the network interface of CIE-M10. You can use a UTP cable. It automatically senses 10Mbps or 100Mbps Ethernet. It also provides auto MDI/MDIX function that can automatically sense a 1:1 cable or cross over cable.

Each Ethernet device has its own hardware address (MAC address). CIE-M10 is shipped to the market with the hardware address set in the factory.

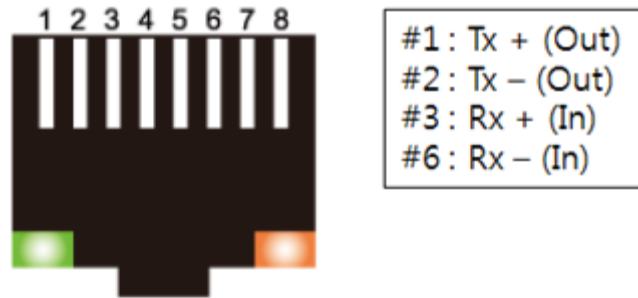

Figure 1-12 the RJ45 connector

1.6.7 RS232 Port (DB9M)

There is a UART port which is CMOS-3.3V level. This port provides serial to TCP/IP converting function working independently with its I/O ports. This port supports RTS/CTS flow control function. The RTS informs to the counter part that its receiving buffer is free and is ready to get data. And CIE-M10 gets CTS information from the counter part's RTS.

Parameters	Supported Values
Baud rate	300 ~ 230,400 bps
Data bits	8, 7, 6, 5
Parity	None, Even, Odd, Mark, Space
Stop bit	1, 1.5, 2

Table 1-4 supported values of the RS232 port

1.6.8 System LED

CIE-M10 has 4 LEDs(PWR, Do0, 2 LEDs on RJ45) to indicate the current system status.

Each LED represents the following status:

Mode	Name	Color	Status	Description
Common	PWR	Red	ON	Power is supplied
Normal mode	STS_ACT	Yellow	Blinking every second	Assigned an IP address
			Blinking 4 times at once	Without being assigned an IP address by DHCP
			ON	Establishing a Modbus/TCP connection
			Blinking	Transferring data to the Ethernet
	LINK_ACT	Green	ON	Connected with a network
			Blinking	Receiving data from the Ethernet
Do0	Green	ON	When Do0 port's signal is ON	
Serial Configuration mode	STS_ACT	Yellow	Blinking simultaneously	Under the serial configuration mode
ISP mode	STS_ACT	Yellow	OFF	Under the ISP mode

Table 1-5 system LED

2 Installation and Test

2.1 Installation

In this section, we explain the operation of CIE-M10 through a test. Basically, its input and output ports are independently used. Thus, you can use either the input ports only for monitoring or the output ports only for control. However, you can also correlatively use those ports by using the MACRO mode on the output ports.

Before testing CIE-M10, you should connect the Ethernet port to a PC. It will be no problem if the Ethernet connection is established through network hubs.

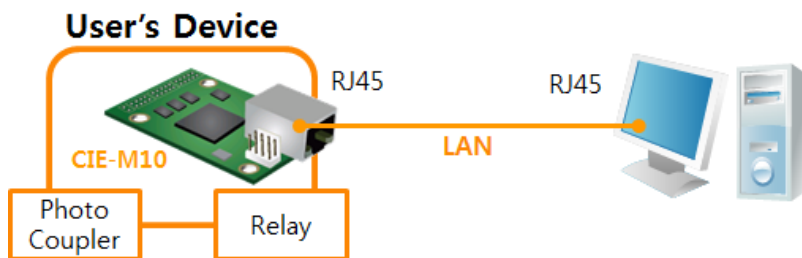

Figure 2-1 the connection between CIE-M10 and a PC

☞ ***Because CIE-M10 is a type of module, you might need designing a board for it. If you cannot design the board, please consider using external product, CIE-M10.***

2.1.1 Setting Network Area

This step is for setting both CIE-M10 and your PC to be located on the same network to establish a TCP connection.

- Setting of the PC

Add or change the IP address of the network adapter on your PC.

Click [Windows Control Panel] >> [Network Connections] and right click of your mouse to get into [Properties of the Network Adapter], then you will see the properties of [Internet Protocol (TCP/IP)]. Press the [Advanced Menu] button and add an IP Address as shown below.

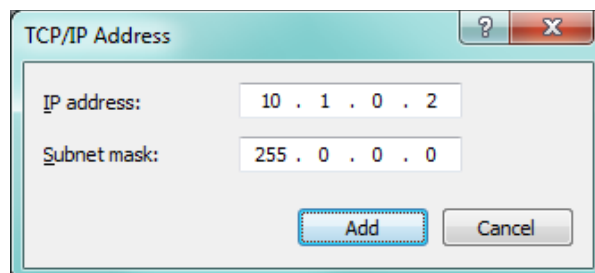

Figure 2-2 adding / changing an IP address

- Setting of CIE-M10

ezManager is the management tool for setting parameters of CIE-M10. This application is only for MS Windows and this is comfortable to use because it does not need installation processes.

First, search your CIE-M10 via network. All the values of parameters are set to the default values in the factory. To apply it to your system, proper values should be set via ezManager.

Default values of some major parameters are listed on the table below. To make the test simple, keep these values during the test.

parameter		value
Network	Local IP Address	10.1.0.1
	Subnet Mask	255.0.0.0
Option	Telnet	Checked
	IP Address Search	Checked
Serial Port	Serial Type	RS232
	Baud Rate	19,200bps
	Parity	NONE
	Data Bits	8
	Stop Bit	1
	Flow	NONE
	Communication Mode	T2S – TCP Server
I/O Port	Local Port	1470
	Web (HTTP)	Checked
	Web (HTTP) Port	80
	Modbus/TCP	Checked
	Master/Slave	Slave
	Connection Mode	Passive Connection
	Multiple Connection	1
Local Port	502	

Table 2-1 default values of some major parameters

☞ ***You can download the latest version of ezManager on the [Download] >> [Utility] page on our website.***

2.2 Test operation

2.2.1 Modbus/TCP Test

This is for checking the operation of Input and output ports of CIE-M10 via Modbus/TCP. In this instruction, Modbus/TCP test program was used.

Run ezManager. Then, you can see the window as shown below.

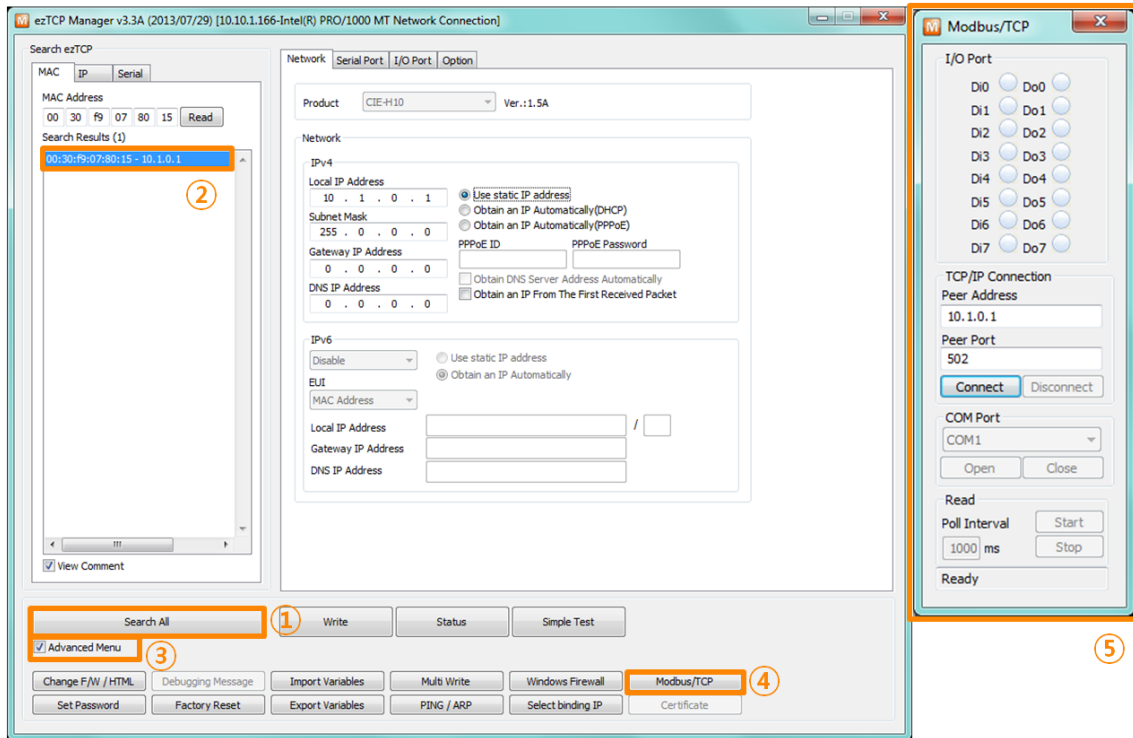

Figure 2-3 Modbus/TCP test program of the ezManager

- ① Search the connected CIE-M10 with [Search All] button.
- ② Select a MAC address of searched product on the [search result].
- ③ Check the [Advanced Menu] option.
- ④ Press the [Modbus/TCP] button.
- ⑤ The test program will appear on the right side of the ezManager

☞ ***In the case of using previous versions of firmware 3.1F the test program is shown automatically when you succeed in searching the product.***

● Modbus/TCP test

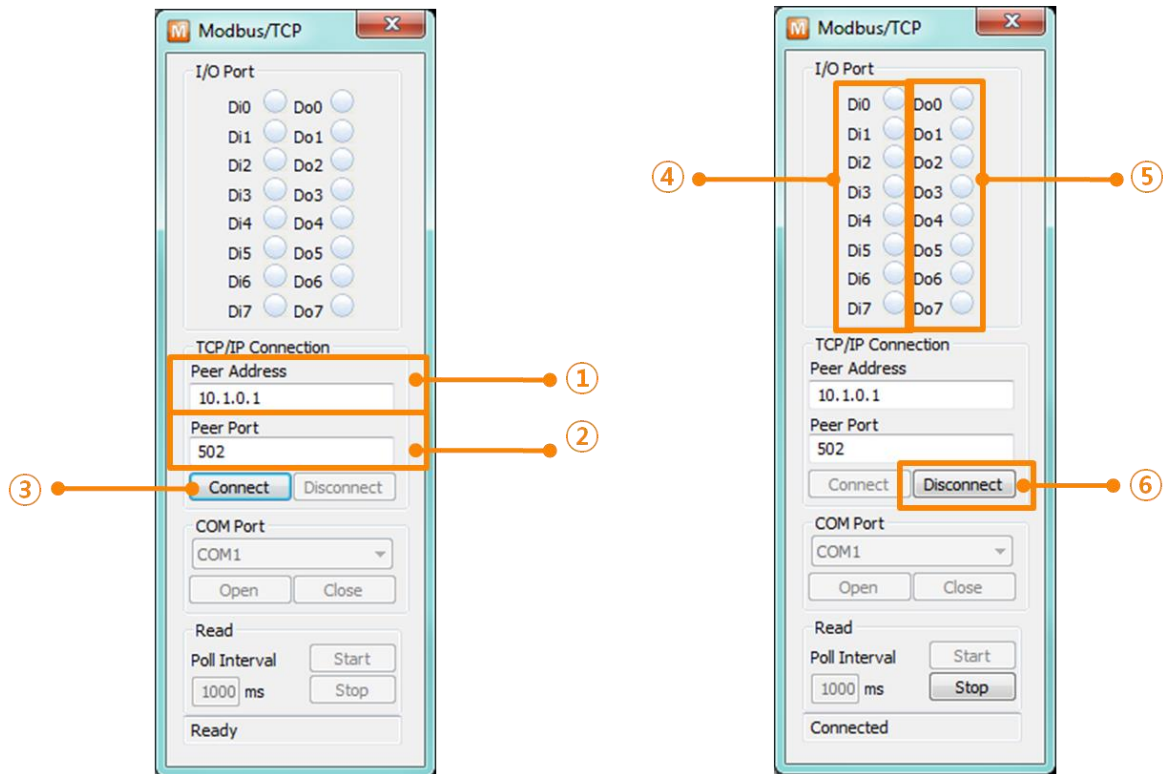

Figure 2-4 Modbus/TCP test

- ① Input the IP address of CIE-M10
- ② Input the local port for Modbus/TCP of CIE-M10

☞ ***In a local area network, ① and ② steps can be omitted.***

- ③ Connect by pressing [Connect] button
- ④ Under the connection, check if the Di LEDs are turned on or off with signal input
- ⑤ Check if Do LEDs are turned on or off with clicking the LEDs
- ⑥ Click the [Disconnect] button after the test is completed

2.2.2 HTTP Test with a WEB browser

This is for testing the operation of Input and output ports of CIE-M10 via HTTP. The test was implemented on a WEB browser. You can use WEB browsers such as MS Internet Explorer, Google Chrome and Mozilla Firefox.

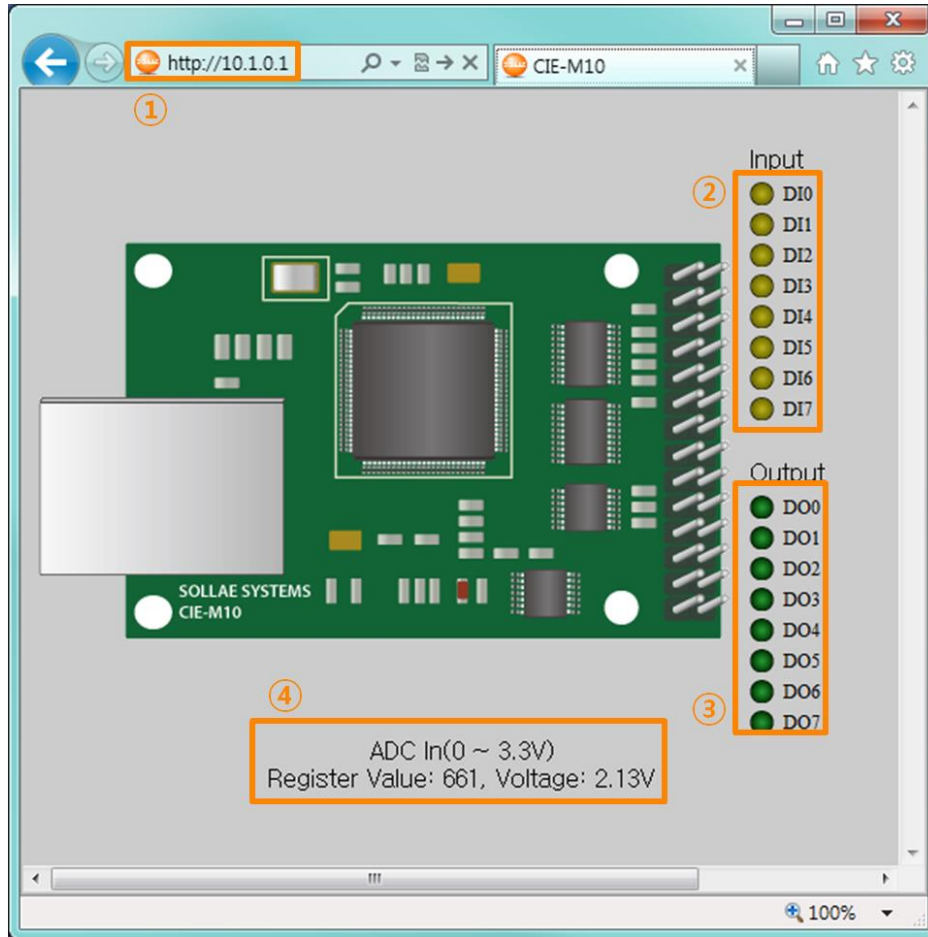

Figure 2-5 HTTP test

- ① Input the IP address of your CIE-M10 on the address field (Ex: 10.1.0.1).
- ② Check if the DI LEDs are turned on or off with HIGH signal.
- ③ Check if DO LEDs are turned on or off with clicking the each of LEDs.
- ④ Check the value of ADC port.

- The way to control output ports manually

	On/Off		Pulse
Parameter	oi (Lower case, i is port number)		pi (Lower case, i is port number)
Value	ON	OFF	Time (ms)
	1	0	1~10000
Example	http://10.1.0.1/index.html?o3=1		http://10.1.0.1/index.html?p3=1000

Table 2-2 The way to control output ports manually

3 Configuration

3.1 Configuration with ezManager

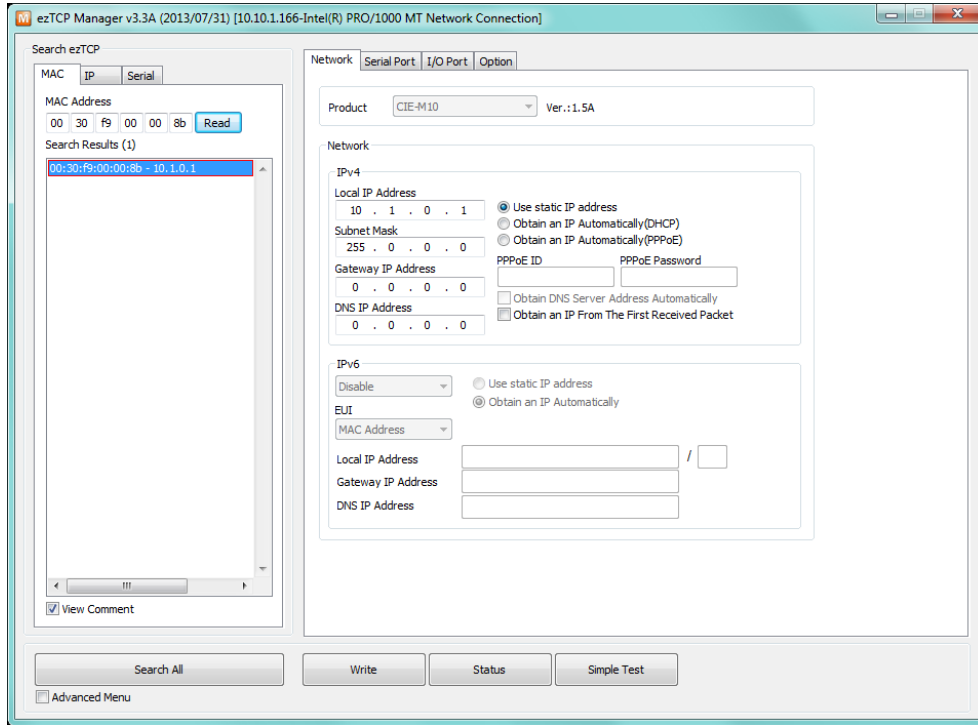

Figure 3-1 initial appearance of ezManager

3.1.1 Configuration via LAN

- Checklists

Make sure of the connection between your PC and CIE-M10 via Ethernet. If they are in the same network, [MAC Address search] button can be used. Otherwise, only [IP Address search] is allowed to use.

- Procedures

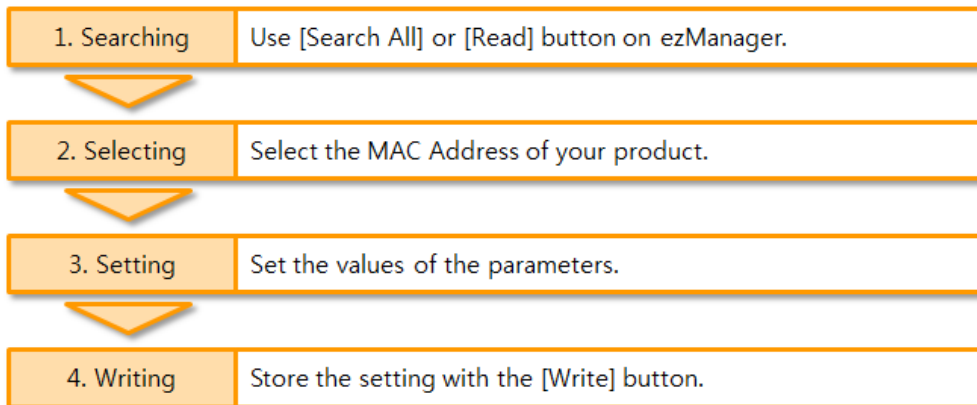

Figure 3-2 procedures for configuration via LAN

3.1.2 Configuration via Serial

- Checklists

Make sure of the connection between your PC and CIE-M10 using a RS232 cross cable. CIE-M10 has to be operating in the [Serial Configuration] mode. You make CIE-M10 operate in the serial configuration mode by connecting ISP- pin with GND (LOW) less than 1 second. After then, read the setting on the [Serial] tab.

- Procedures

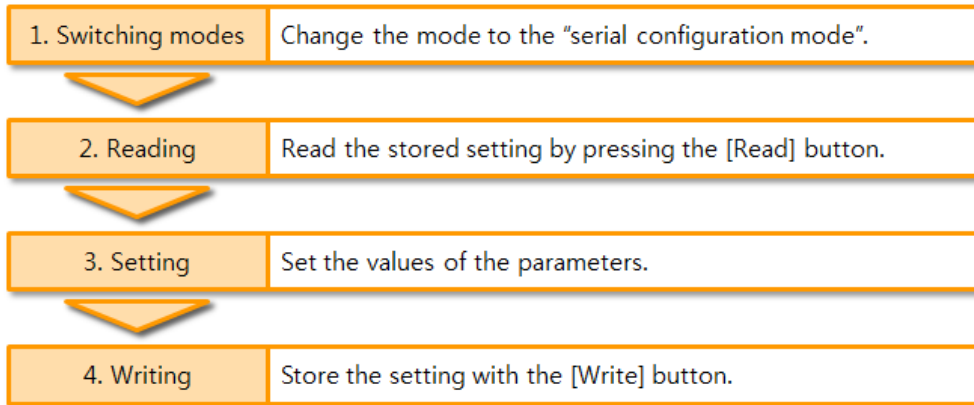

Figure 3-3 procedures for configuration via serial port

- Step 2, Reading

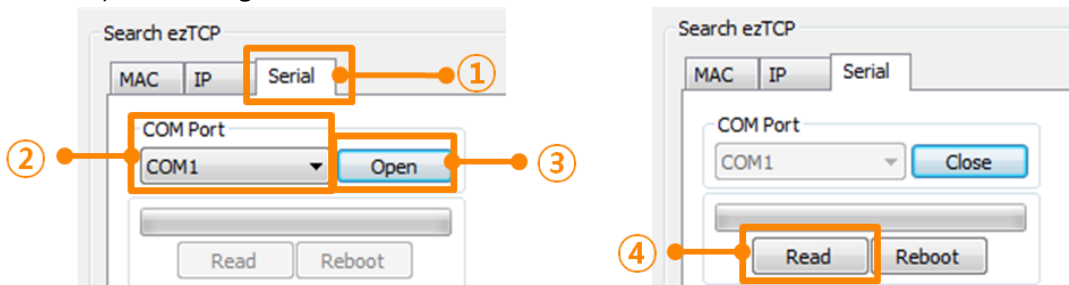

Figure 3-4 reading procedure via serial

- ① Choose the [Serial] tab.
- ② Select the COM port which is the device is connected.
- ③ Open the COM port pressing the [Open] button.
- ④ Load the setting with the [Read] button.

☞ Refer to the document [ezManager Users' Manual] on our website for details.

3.2 AT command

In the AT command mode, you can change some parameters through the serial port.

- Checklists

Make sure of the connection between your PC and CIE-M10 using a RS232 cross cable. All the parameters of the serial port between CIE-M10 and the Terminal of your PC should be the same. In the AT command mode, you can change some parameters through the serial port.

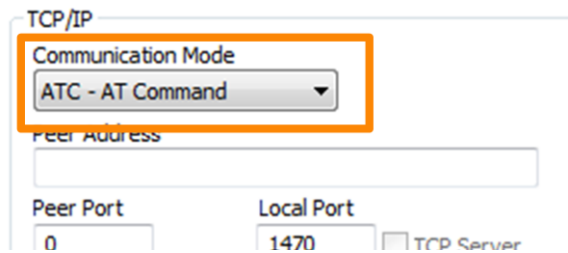

Figure 3-5 setting the communication mode to the AT command

- Procedures

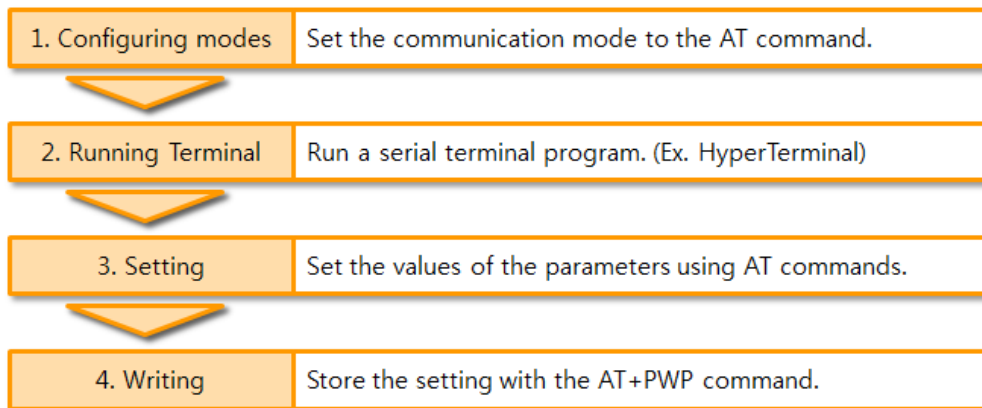

Figure 3-6 procedures for configuration with AT command

Division	Available parameters
IP Address related items	Local IP Address, DHCP, Subnet Mask, Gateway IP Address, DNS IP Address, ...
A TCP connection related items	Local Port, Peer Address (IP Address or Host name), Peer Port, ...
Option	ESC code sending option, timeout, ...

Table 3-1 parameters which are changeable via AT command

☞ **Including above items, rest of parameters can be set via ezManager**

4 Operation Modes

4.1 What is the Operation Mode?

Each of three operation modes are designed for specific purposes, and those are as follows:

- Normal mode
This mode is for normal data communication and has 5 different communication modes. Configuring parameters is also available in this mode.
- Serial configuration mode
This mode is for configuring environmental parameters through the RS-232 port.
- ISP mode
This mode is for upgrading firmware and HTML files. In addition, you can set environmental parameters even though the security options are activated. You can also reset the security options.

4.2 How to change the mode to another

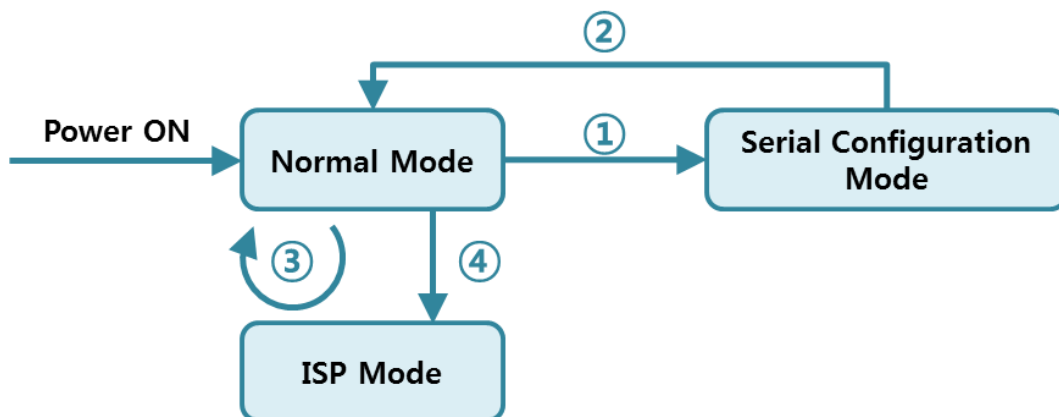

Figure 4-1 How to enter into each mode

- ① Set ISP- pin to LOW less than 1 sec.
- ② Reset
- ③ Transfer a firmware via ezManager
- ④ Set ISP- pin to LOW over 1 second

4.3 Comparison of the each mode

The following table shows summaries of each mode.

name	entering	serial port
Normal	Supply the power.	Configured value
Serial Configuration	Connect the ISP- pin to GND(low) less than 1 sec.	115,200/N/8/1
ISP	Connect the ISP- pin to GND (low) over 1 second or Give Low to the ISP-pin when it boots up.	115,200/N/8/1

Table 4-1 comparison of each mode

4.4 Normal Mode

In normal mode, there are four ways to monitor and control I/O and an additional operation which operates as a Serial to Ethernet converter.

- I/O controller

type	description
Modbus/TCP	Control and monitor the I/O of CIE-M10 via Modbus/TCP. It supports both master and slave mode.
Serialized Modbus/TCP	CIE-M10 communicates through the RS232 port using the data format of Modbus/TCP.
Macro	Output ports can be controlled automatically by setting MACRO using some basic formula of Boolean Algebra. If a port is set to MACRO mode, it cannot be controlled through HTTP and Modbus/TCP. This mode is usually used to control output port basing on state of input port.
WEB(HTTP)	Users can monitor and control CIE-M10 via HTTP

Table 4-2 digital I/O control types

- Serial-Ethernet converter

CIE-M10 can be used as a Serial to Ethernet converter. There are four communication modes in this operation.

name	protocol	connection	modifying software of serial devices	serial configuration	topology
TCP Server	TCP	Passive	-	Not available	1:1
TCP Client		Active	-	Not available	1:1
AT Command		Either	Required	Available	1:1

UDP	UDP	-	-	Not available	N:M
-----	-----	---	---	---------------	-----

Table 4-3 comparison of four communication modes

4.5 Serial Configuration mode

4.5.1 Configuring Parameters

This is a mode for setting environmental parameters through the serial port. If you cannot use the Network, this mode is only way to configure the parameters. Click the [Read] button on the [Serial] tab on ezManager after entering this mode.

☞ ***Refer to the [Serial Management Protocol] document on our website for details.***

4.5.2 Revoking Security Options

CIE-M10 offers strong functions for security like filtering with password or MAC and IP addresses. In the Serial Configuration mode, you can revoke all of these options. When you forget the password, enter this mode to change or delete it.

4.6 ISP mode

4.6.1 Upgrading Firmware

ISP mode is for upgrading firmware. Upgrading Firmware is implemented by ezManager. For more details about this, please refer to the section 7.1.

4.6.2 Upgrading HTML

ISP mode can also upgrade HTML files. For more details about this, please refer to the section 7.2.

4.6.3 Revoking Security Options

In the ISP mode, you can revoke all of these options like the serial configuration mode. When you forget the password, enter this mode to change or delete it.

5 Methods for I/O control

5.1 Modbus/TCP

CIE-M10 supports Modbus/TCP. By using this protocol, it remotely monitors and controls I/O devices. To use this method, users' application should support this protocol.

5.1.1 .Related Parameters

parameter	description
Modbus/TCP	Using Modbus/TCP for controlling I/O ports of CIE-M10.
Slave	The slave responses by queries from the Master
Master	The Master sends queries to the slaves
Poll Interval	the period for sending queries (Unit: ms, Minimum value: 10)
Unit ID	ID for identifying the device or the pair of devices.
Input Port Base Address	Initial address of the input ports
Output Port Base Address	Initial address of the output ports
Passive Connection	waiting for accepting a Modbus/TCP connection
Active Connection	requesting a Modbus/TCP connection
Multiple Connection	The numbers for multiple Modbus/TCP connections.
Control Method of (FC XX)	Control method for the output ports of the slave (Single / Multiple)
Control Method of (AND/OR)	Control method for the output ports of the master (AND / OR)
Peer Address	Peer's IP address when CIE-M10 performs active connections
Peer Port (Active)	Peer's port when CIE-M10 performs active connections.
Local port (Passive)	CIE-M10's local port when CIE-M10 performs passive connections.
Input Change Notification	A function for immediate notification of changing the IP address.
Initialize the output port state	The Output port will be changed to the [Initial State] when Modbus/TCP is disconnected. (Upper version 1.5A)
Macro	Applying macro function on the output port
Initial State	Output port value when CIE-M10 boots up.

Table 5-1 Modbus/TCP related parameters

We do not recommend changing the [Input Port Base Address] and [Output Port Base Address] unless you need to.

5.1.2 Modbus/TCP Slave Mode

According to the standard Modbus/TCP, users can use a Modbus/TCP manager to control and monitor their I/O devices. You can set CIE-M10 to the [Slave] item to [Slave] mode. The [Passive] connection is recommended in this mode and the [Peer Port] should be 502.

Modbus/TCP Mode	Slave
TCP Connection	Passive
TCP Port	502

Table 5-2 values for standard Modbus/TCP

Configure the proper values of [Unit ID], [Input Port Base Address], and [Output Port Base Address].

5.1.3 Modbus/TCP Master Mode

In this mode, CIE-M10 operates as a Modbus/TCP master. As a master CIE-M10 transmits its input information to the slave and outputs the slave's input value to its output port after reading the value periodically. At this stage, CIE-M10 controls the output ports with not only bit unit (individually) but also word unit (at once)

- FC 16(Multiple ports)

CIE-M10 controls the output ports and monitors the input ports of slaves with WORD unit by FC16 (write multiple register) and FC 03 (read multiple register)

- FC 05(Single port)

CIE-M10 controls the output ports and monitors the input ports of slaves with BIT unit by FC05 (write coil) and FC02 (read input discretely).

5.1.4 TCP Connection Modes

In the standard of Modbus TCP, the master program makes a connection to the slave using port number 502. However, sometimes Modbus/TCP devices try connecting to the master actively. For this case, CIE-M10 supports the active connection mode.

passive connection	<ul style="list-style-type: none"> - Standard Modbus/TCP. - Remote host connects to CIE-M10. - Port number that is used for communication must be designated. - Depending on the setting of multiple connections, up to 8 hosts can be connected simultaneously.
active connection	<ul style="list-style-type: none"> - CIE-M10 tries to establish a connection to the remote host. - The IP address (or host name) and port number of the remote host are required.

Table 5-3 the passive / active connection

5.1.5 Initial State

The initial state of CIE-M10's output ports can be configured. The output ports are set to ON or OFF according to the value of [Initial State] at the boot time.

5.1.6 Write Pulse

By using the function code 105(0x69), you can give the signal of pulse type to the output ports. This means the output signal is kept during the specific time configured by users.

☞ ***Refer to the document [Modbus/TCP protocol] on our website for details.***

5.2 Serialized Modbus/TCP

Since 1.3A firmware, serialized Modbus/TCP mode had been added on the firmware. In this mode, CIE-M10 sends and receives Modbus/TCP data via the serial port. By using this mode, you can monitor and control the I/O ports of CIE-M10 through the RS232 port.

Note that you can't control the output ports of CIE-M10 with HTTP or Modbus/TCP in this mode. Also, the TCP and UDP data communication for serial devices cannot be activated.

5.3 Macro Mode

This mode lets users set the values of the output ports with simple macros. Since CIE-M10 reflects the values according to the macro expressions which are configured by users in advance, it is useful to make a specific device operate automatically using signals from various sensors. Check [Macro] options on ezManager to activate this mode.

☞ ***If a port is set to Macro mode, it cannot be controlled through HTTP or Modbus/TCP.***

5.3.1 Operator

The equation used in the Macro mode is Boolean algebra. In this case, the AND, OR, NOT are used as operators. Parenthesis may also be used.

The operators are executed in order of precedence: parenthesis > NOT > AND > OR.

Each operator is represented by the following symbols.

name	sign	description
Parenthesis	()	Since calculations within the parenthesis have the highest priority, they will be calculated first. Nested parentheses are allowed.
NOT	/	An operand that follows a NOT operator is toggled. (If an operand is 0, it will be changed to 1. If it is 1, it will be changed to 0.)
AND	*	If both operand values surrounding an AND operator are 1, the result value will be 1. Otherwise, the result will be 0.
OR	+	If both operand values surrounding an OR operator are 0, the result value will be 0. Otherwise, the result will be 1.

Table 5-4 the operators

5.3.2 Operand

Operands used in macro mode are each input port. Each input port is designated with i0 ~ i7 symbol based on their sequence. Since operands are case-insensitive, they can also be written as I0 ~I7.

☞ ***The output ports could not be used as an operand.***

5.3.3 An Example of Equations

Here are some examples. In the expressions, spaces between the two operands will be ignored.

Input Port	Equations	Description
Do0	$i0 + i1$	Perform OR for i0 and i1.
Do2	$i0 * /(i1 + i7)$	The part of the expression within the parentheses, (i1 + i7) is evaluated first, and then the value is toggled due to a NOT operator. This result is used to perform an AND operator with i0.

Table 5-5 an example of equation

The following is the output values coming out as a result of expressions of input values.

Input port value			Output port value	
i0	i1	i7	Do0	Do2
0	0	0	0	0
0	0	1	0	0
0	1	0	1	0
0	1	1	1	0
1	0	0	1	1
1	0	1	1	0
1	1	0	1	0
1	1	1	1	0

Table 5-6 the logic table of the table 5-5

5.4 Web (HTTP)

After starting the web browser, type CIE-M10's IP address in the address bar to connect to CIE-M10.

If a password for CIE-M10 is set, the following window will be popped up.

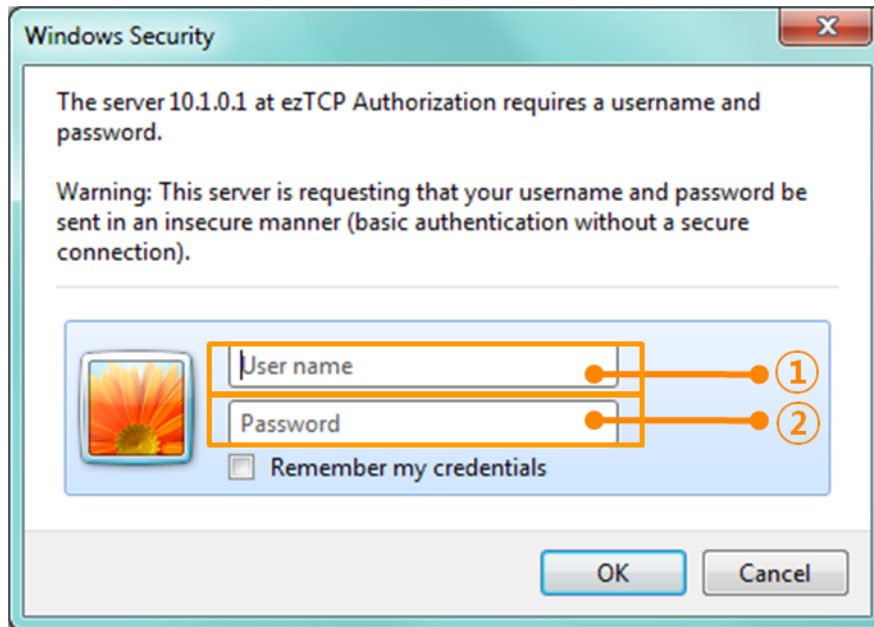

Figure 5-1 authentication with a password

- ① [User name] is not required. Leave blank or put a random name.
- ② [Password] should be the same with a password which is set through the ezManager.

5.4.1 Changing the Web(HTTP) port

In case you cannot use the port number 80(default port number for HTTP) because the ISP (Internet Service Provider) blocks the port, you can change that port number.

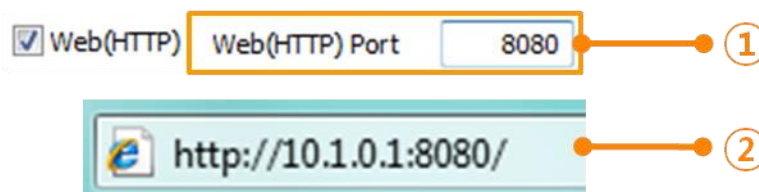

Figure 5-2 changing port number for HTTP

- ① Change HTTP port number on CIE-M10 via ezManager
- ② Input the IP address of CIE-H14 along with the changed port number and "http://" on a Web Browser

5.4.2 Uploading Users' Web Page

1.3A or subsequent versions of firmware support uploading custom web page. This function is available to anyone who can make HTML files. If you get some simple syntax, it is possible to monitor and control the I/O ports with your homepage interface.

- Upgrading Boot and Firmware

CIE-M10 has a default web page (HTML file). Except for the page, we offer other samples such as text and simple image type and etc. so you can use those sample codes on our web site.

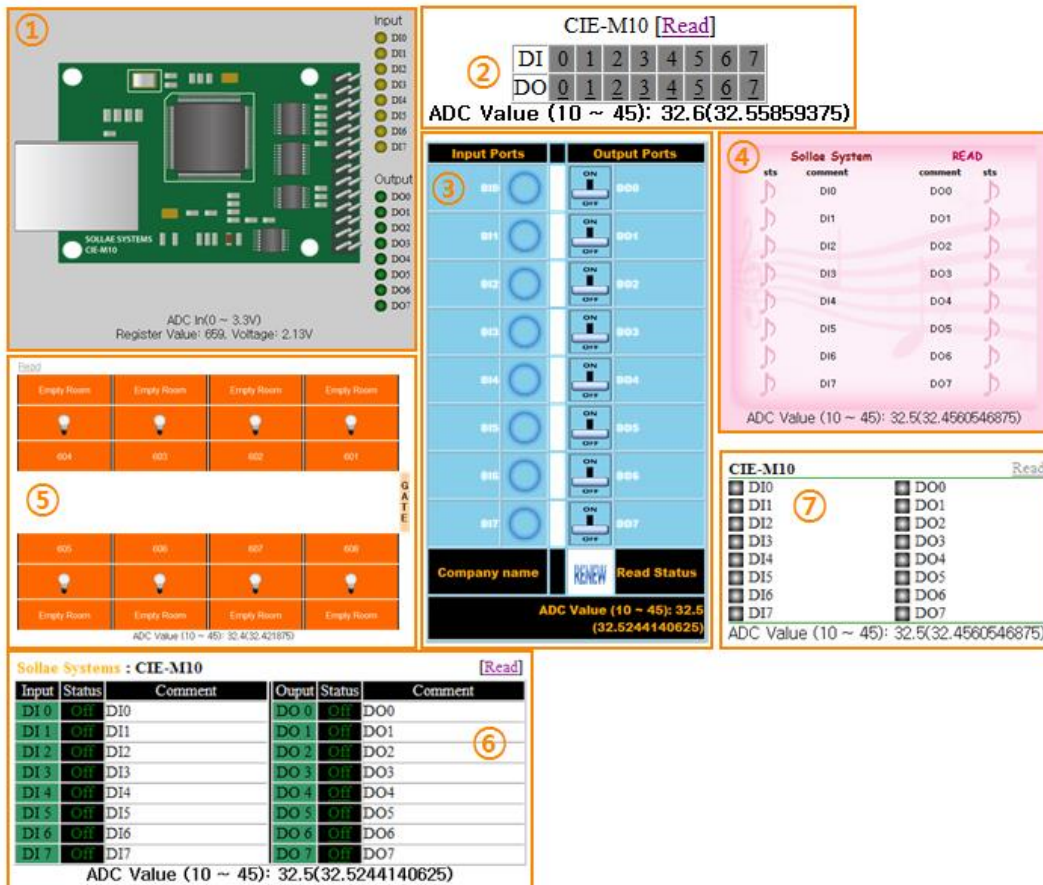

Figure 5-3 examples of web page

- ① Default image
- ② No comment
- ③ Sample01
- ④ Sample02
- ⑤ Sample03
- ⑥ Simple text
- ⑦ Simple image

6 Communication Modes

CIE-M10 provides RS232 to TCP/IP conversion function along with input/output port monitoring and controlling function.

6.1 TCP Server

In this mode, CIE-M10 acts as a TCP server. CIE-M10 waits for a TCP connection from remote hosts. Once one of hosts tries to connect to CIE-M10, it responds to that request. After the connection is established, CIE-M10 converts the raw data from the serial port to TCP/IP packets and sends the packets to the network and vice versa.

6.1.1 Key parameters

- Local Port

This is a server's port number which is used in the TCP connection.

- Event Byte

With setting event bytes, users can handle the serial data received before a TCP connection is established.

Value	Description
0	CIE-M10 does not send the data received before a TCP connection is established.
Otherwise (512 or under)	CIE-M10 sends the data, which is received before a TCP connection is established, right after a connection is established. 512 or under bytes are strongly recommended.

Table 6-1 Event Byte

- Timeout

If there is no data transmission for the specific time, CIE-M10 terminates the established TCP connection.

- Notify IP Change

This function is for notifying information about changed IP address to a server. Not only the TCP/UDP protocol but also Dynamic Domain Name Service (DDNS) can be used.

- Restriction of Access (ezTCP Firewall)

Users can block TCP connections from unauthorized hosts by using this option. Both IP and MAC address are available.

6.1.2 An Example

- An example as a TCP server

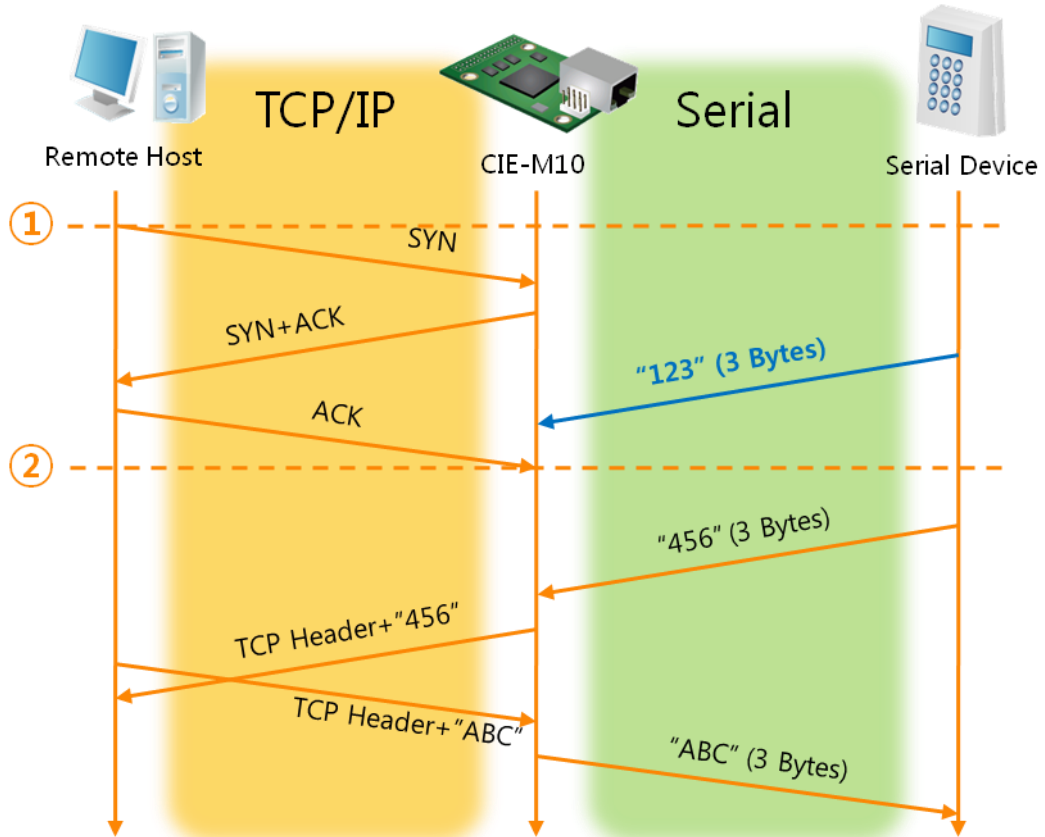

Figure 6-1 TCP server time chart in the case [Event Byte] is set to 0

Time	States
~	CIE-M10 is waiting for request segments of a TCP connection
①	Remote host has sent a request (SYN) segment
~	Processes of the connection
②	The connection has been established
~	Data communication on both sides

Table 6-2 descriptions of each states

6.2 TCP Client

In this mode, CIE-M10 acts as a TCP client. CIE-M10 sends request segments to a remote host with information of [Peer Address] and [Peer Port]. Under situation that the TCP server works fine with the specific port, the connection will be established. After then, CIE-M10 converts the raw data from the serial port to TCP/IP data and sends them to the network and vice versa.

6.2.1 Key parameters

- Peer Address
This item should be an address of a remote host who is waiting requests of a TCP connection.
- Peer Port
[Peer Port] should be the port number which is designated by the remote host.
- Event Byte
CIE-M10 decides the time to send request segments for the TCP connection with this parameter.

Value	Description
0	CIE-M10 sends a request segment of the TCP connection right after it boots up
Otherwise (512 or under)	CIE-M10 sends the segment right after it received amount of data which is set to the [Event Byte] from the serial port

Table 6-3 the operation of Event Byte 1

In addition, users can handle the serial data received before a TCP connection is established by setting this parameter.

Value	Description
0	CIE-M10 doesn't send the data received before a TCP connection is established.
Otherwise (512 or under)	CIE-M10 sends the data, which is received before a TCP connection is established, right after a connection is established. 512 or under bytes are strongly recommended.

Table 6-4 the operation of Event Byte 2

- Timeout
If there is no data transmission for the specific time, CIE-M10 terminates the established TCP connection.
- TCP Server

This check option is enable the TCP server / client mode. In this mode, CIE-M10 can be operated as a TCP server or client without changing its setting.

- DNS IP Address
[DNS IP Address] is required when users use a host name instead of the IP address on the [Peer Port] parameter.

6.2.2 An Example

- An example of TCP client

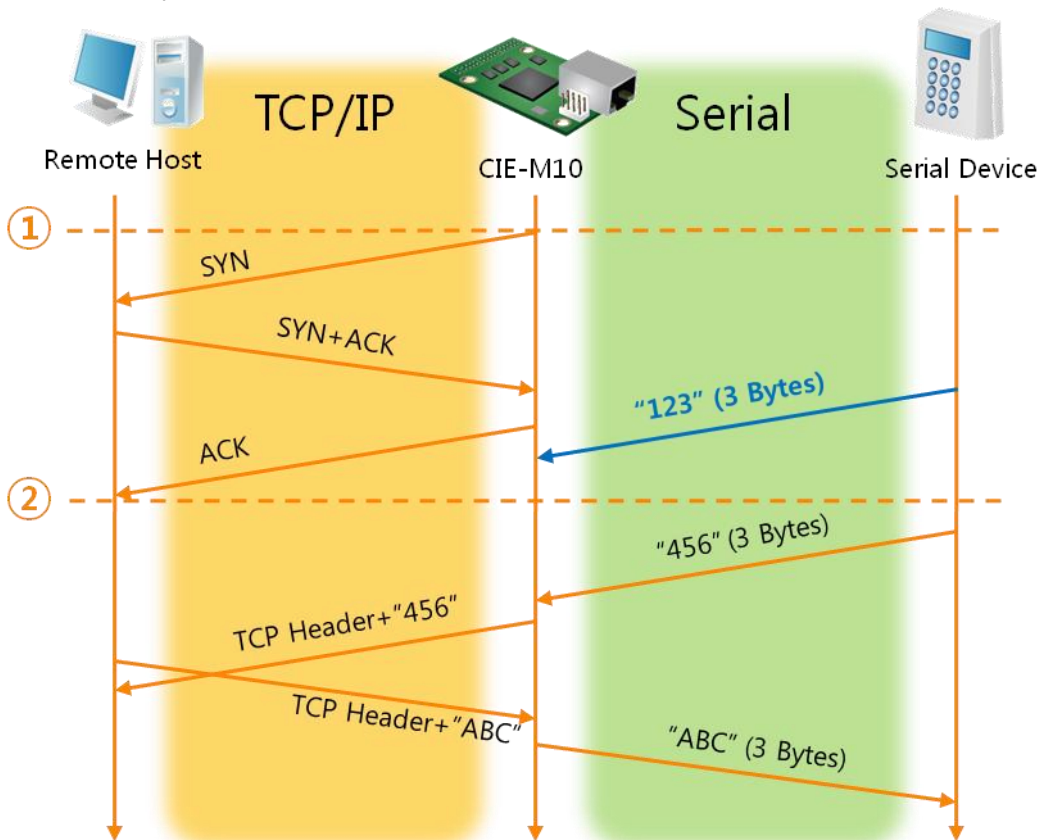

Figure 6-2 time chart in the case [Event Byte] is set to 0

Time	States
~	Before the power is supplied
①	Sends request segments of a TCP connection right after it boots up
~	Processes of the disconnection
②	The connection has been established
~	Data communication on both sides

Table 6-5 descriptions of each states

- TCP Server/Client mode

In the TCP client mode, the [TCP Server] check option is activated. If you check this option, CIE-M10 operates in the TCP server/client mode. In this mode, CIE-M10 can establish a TCP connection both actively and passively without changing any settings.

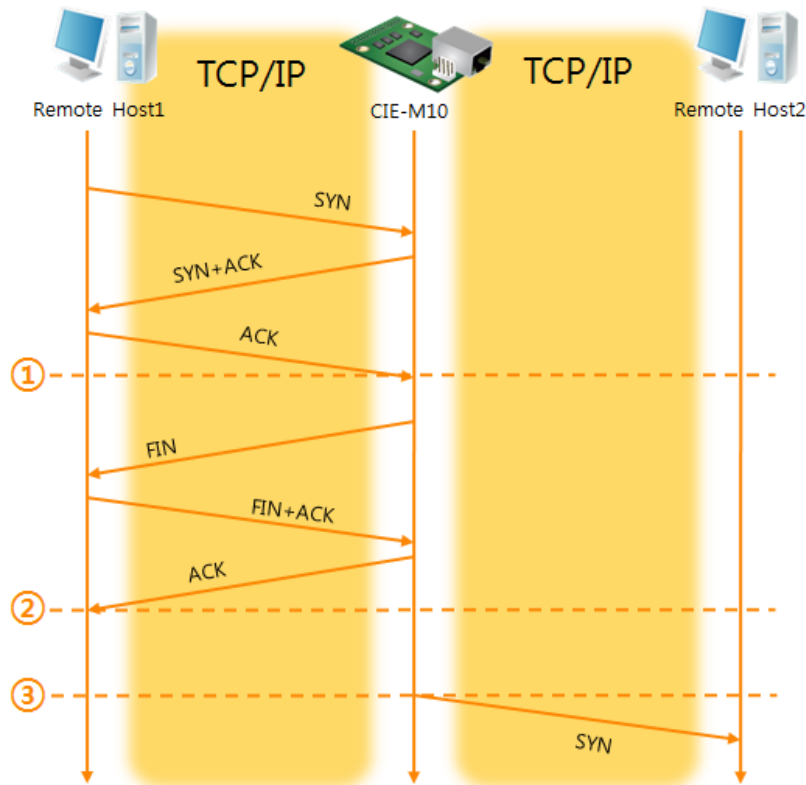

Figure 6-3 time chart for activating [TCP Server] option

Time	States
~	CIE-M10 is waiting for request segments of a TCP connection
①	The connection has been established
~	CIE-M10 is on line and processes of the disconnection
②	The connection has been terminated
~	Both sides are offline
③	Sends a request segment of a TCP connection

Table 6-6 descriptions of each states

The TCP Server/Client mode only can be a useful option under condition of using [Event Byte] and [Timeout]. Note that only one TCP connection can be established at the same time, so users should consider setting [Timeout] properly.

☞ **Refer to the [TCP Server/Client mode] document on our web site for details.**

6.3 AT Command

AT command is a mode which users control CIE-M10 by using AT command like controlling modem. In this mode, active and passive TCP connections are available. And users are allowed to configure some environmental parameters by using the extended commands.

6.3.1 Key parameters

The configuration should be implemented via the serial port of M10

Commands	Description	Examples
+plip	Local IP Address	at+plip=10.1.0.1<CR>
+plp	Local Port	at+plp=1470<CR>
+prip	Peer IP Address	at+prip=10.1.0.2<CR>
+prp	Peer Port	at+prp=1470<CR>
+pdc	DHCP	at+pdc=1<CR> (On)
+pto	Timeout	at+pto=10<CR>
+pwp	Store setting	at+pwp<CR>

Table 6-7 some of extended commands for configuration

- Items related to the IP Address and Local Port
Like the local port and IP address, other related parameters such as IP Address, Subnet Mask and Gateway IP Address can be set.
- Peer Address / Peer Port
IP address and local port of a remote host are can be set.
- Type of assigning the IP address: Manual, DHCP
Not only manual setting, also automatic assigning protocol (DHCP) is available.
- The others
Some of options including [Timeout] can be configured in this mode.

6.3.2 Examples

- TCP Server – setting parameters and a passive connection

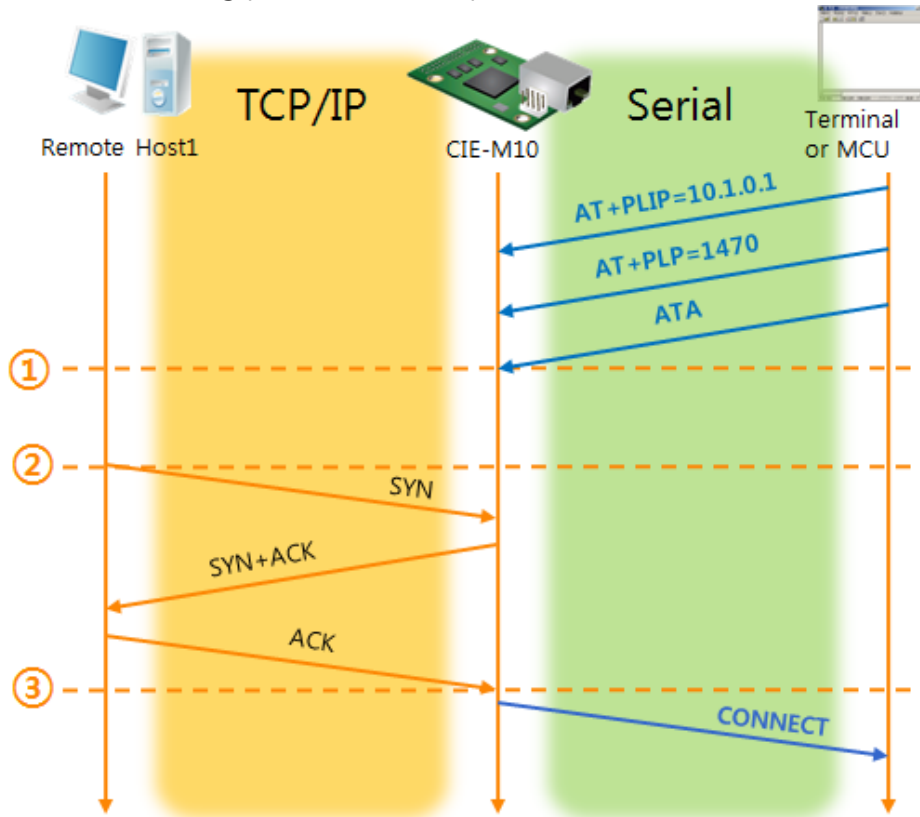

Figure 6-4 a passive TCP connection

Time	States
~	Set parameters in the AT command mode
①	CIE-M10 waits request segments of a TCP connection with the ATA command
~	CIE-M10 is waiting for requests of a TCP connection
②	A remote host has sent SYN segment to CIE-M10
~	Processes of the TCP connection
③	TCP connection has been established
~	CIE-M10 sends "CONNECT" message to the serial port

Table 6-8 descriptions of each states

☞ **Most of the response messages from the serial port of CIE-M10 are omitted on above figure.**

- TCP Client – setting parameters and an active connection

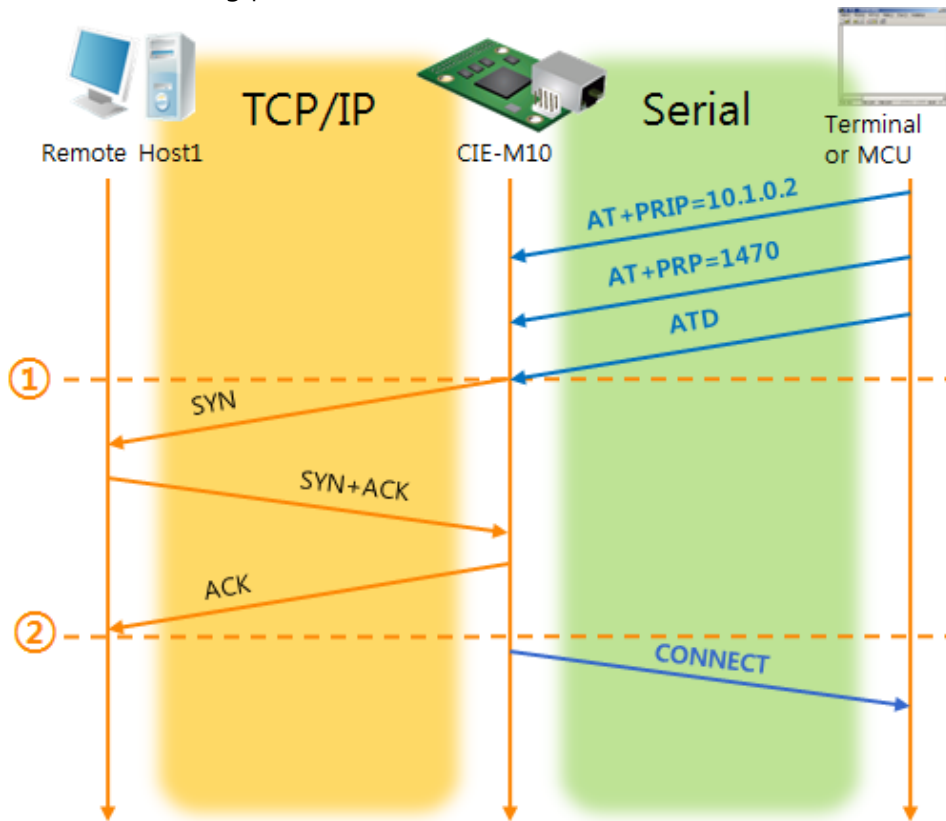

Figure 6-5 an active TCP connection

Time	States
~	Set parameters in the AT command mode
①	CIE-M10 sends a request segment of a TCP connection with the ATD command.
~	Processes of the TCP connection
②	The TCP connection has been established.
~	CIE-M10 sends "CONNECT" message to the serial port.

Table 6-9 descriptions of each states

☞ Refer to the [AT Command mode - ATC] document on our web site for details.

6.4 UDP

UDP has no processes of a connection. In this mode, data is sent in block units. Therefore, data that comes through CIE-M10's serial port must be classified in block units to be sent elsewhere.

6.4.1 Key parameters

- Block Size(Byte)

[Block Size] means the size of a block in UDP mode. Its unit is byte. Recognizing specific sized data coming into the serial port, CIE-M10 sends them as one block to the network. The value is up to 1460 bytes.

- Data Frame Interval

[Data Frame Interval] means the time for gathering data to make them into a block. Its unit is 10ms. If there is no transmission for specific time which is set to this value, CIE-M10 sends gathered data in the buffer as one block to the network.

☞ ***Please set this value to 11 or higher values for correct operation.***

☞ ***A UDP packet block is sent if applicable to either of [Block Size] and [Data frame Interval].***

- Dynamic update of Peer host

If users set the value of [Peer Address] and [Peer Port] to 0, [dynamic update of peer host] function is activated. By using this function, CIE-M10 can communicate with multiple hosts without additional setting.

6.4.2 Examples

- Block Size: 5 bytes / Data Frame Interval: 1s (100 * 10ms)

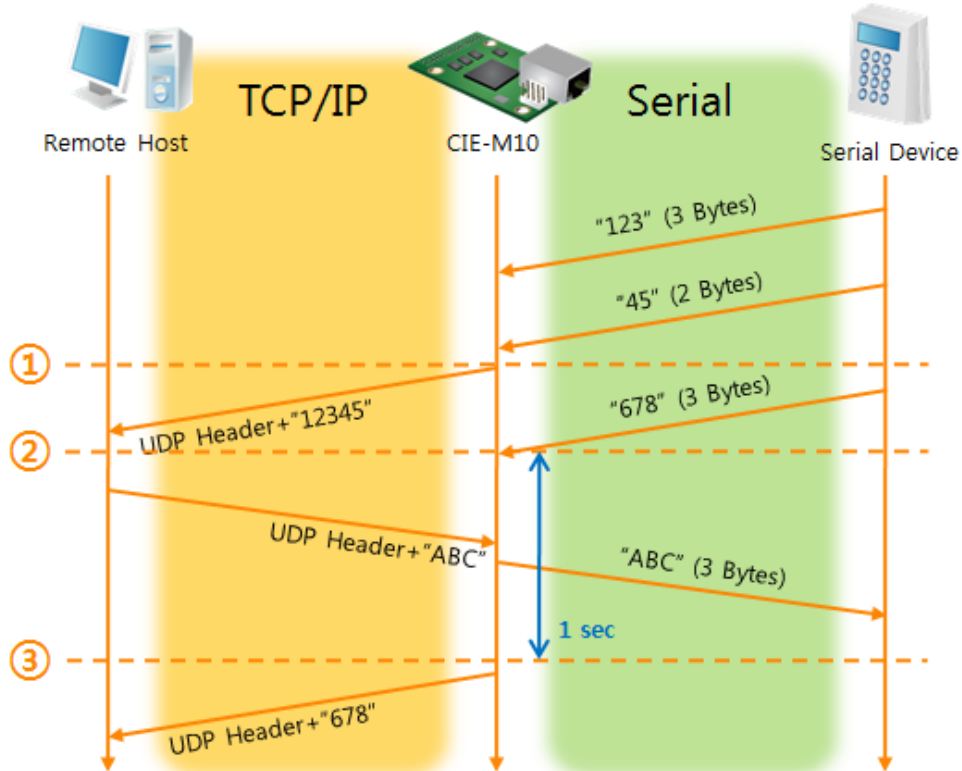

Figure 6-6 time chart for block size is 5 bytes and data frame interval is 1s

Time	States
~	CIE-M10 is receiving data from the serial port
①	CIE-M10 Sends 5 bytes as one block based on the [Block Size]
~	Serial device sends data "678" to CIE-M10
②	Data "678" has arrived
~	CIE-M10 sends data from the remote host to the serial device
③	1 second has passed
~	CIE-M10 sends data "678" based on the [Data frame Interval]

Table 6-10 descriptions of each states

- Dynamic Update of Peer host

This is a function that CIE-M10 automatically sets its peer host with information of the last packet which is received from network. In the packet, the source address and port number are used.

Parameter	Value
Peer Address	None
Peer Port	0

Table 6-11 setting for [dynamic update of peer host] function

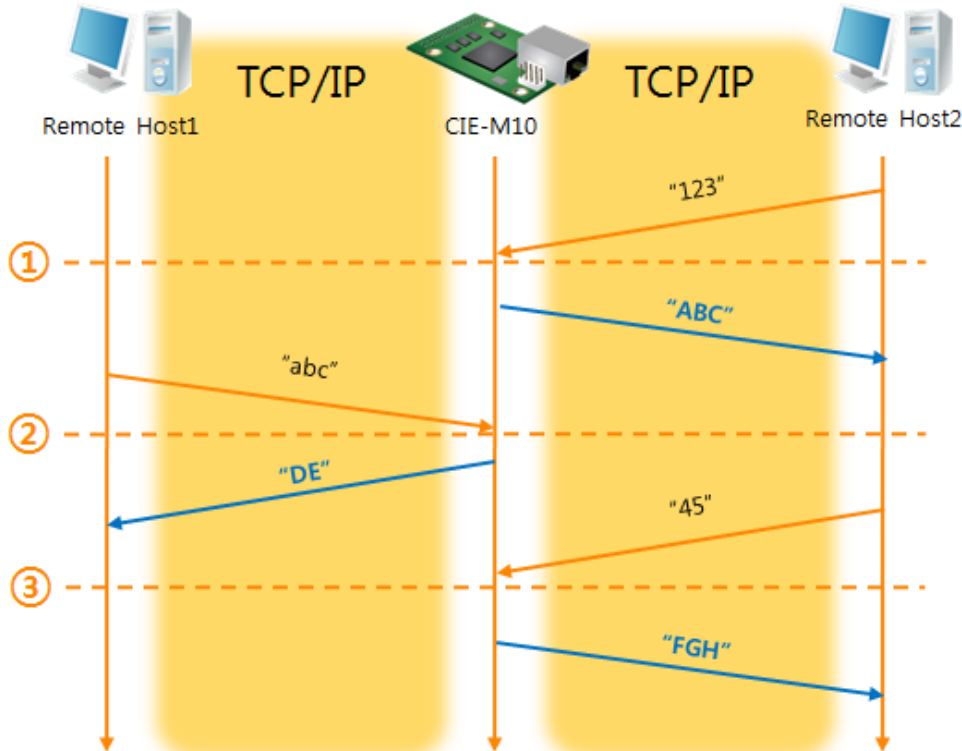

Figure 6-7 time chart for [dynamic update of peer host]

Time	States
~	Sending any UDP data to the network is impossible.
①	UDP data arrives from Remote Host 2.
~	Send UDP data to Remote Host 2.
②	UDP data arrives from Remote Host 1.
~	Send UDP data to Remote Host 1.
③	UDP data arrives from Remote Host 2.
~	Send UDP data to Remote Host 2.

Table 6-12 descriptions of each state

☞ ***"ABC", "DE", and "FGH" in the above figure are the data that CIE-M10 receives from a serial port and send to the network.***

7 System Management

7.1 Upgrading Firmware

7.1.1 Firmware

Firmware is a type of software for operation of CIE-M10. If it is needed to add function or fix bugs, the firmware will be modified and released. We recommend that users keep using the latest released firmware.

7.1.2 Processes

- Downloading the latest released firmware
Download the newest firmware file. We update our homepage when a new firmware is released. You can find it on our website.
- Entering ISP mode
Enter ISP mode to download firmware file to CIE-M10.
- Run a TFTP client and ready to send the F/W file
Run a TFTP client program. ezManager is equipped with the client program. Click the [Change F/W / HTML] button.

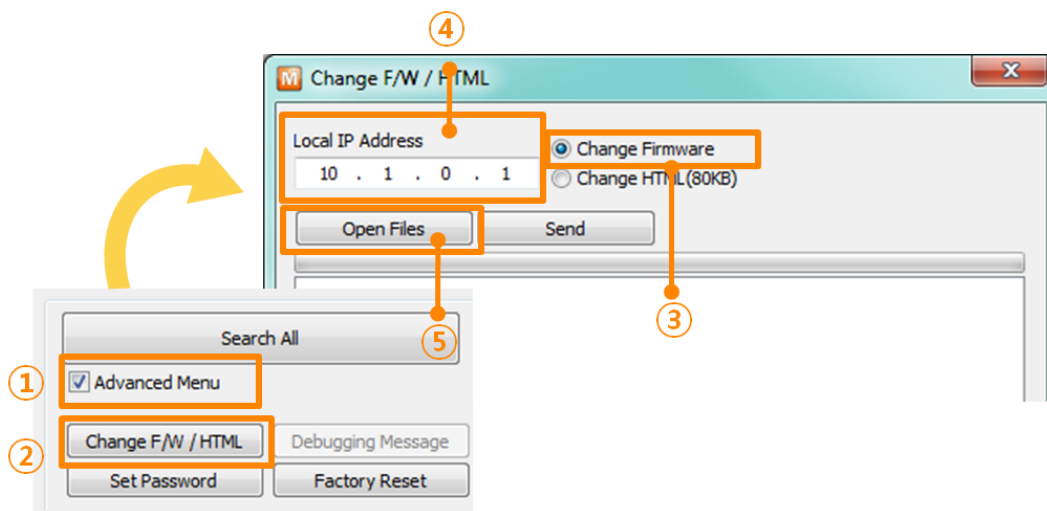

Figure 7-1 running TFTP client

- ① Check the [Advanced Menu] check box
- ② Click the [Change F/W / HTML] button to run TFTP client
- ③ Select the [Change Firmware] radio button
- ④ Input the IP address of CIE-M10 to the [Local IP Address] text box
- ⑤ Press the [Open Firmware / HTML] button and choose the firmware file

- Checking firmware file and Sending

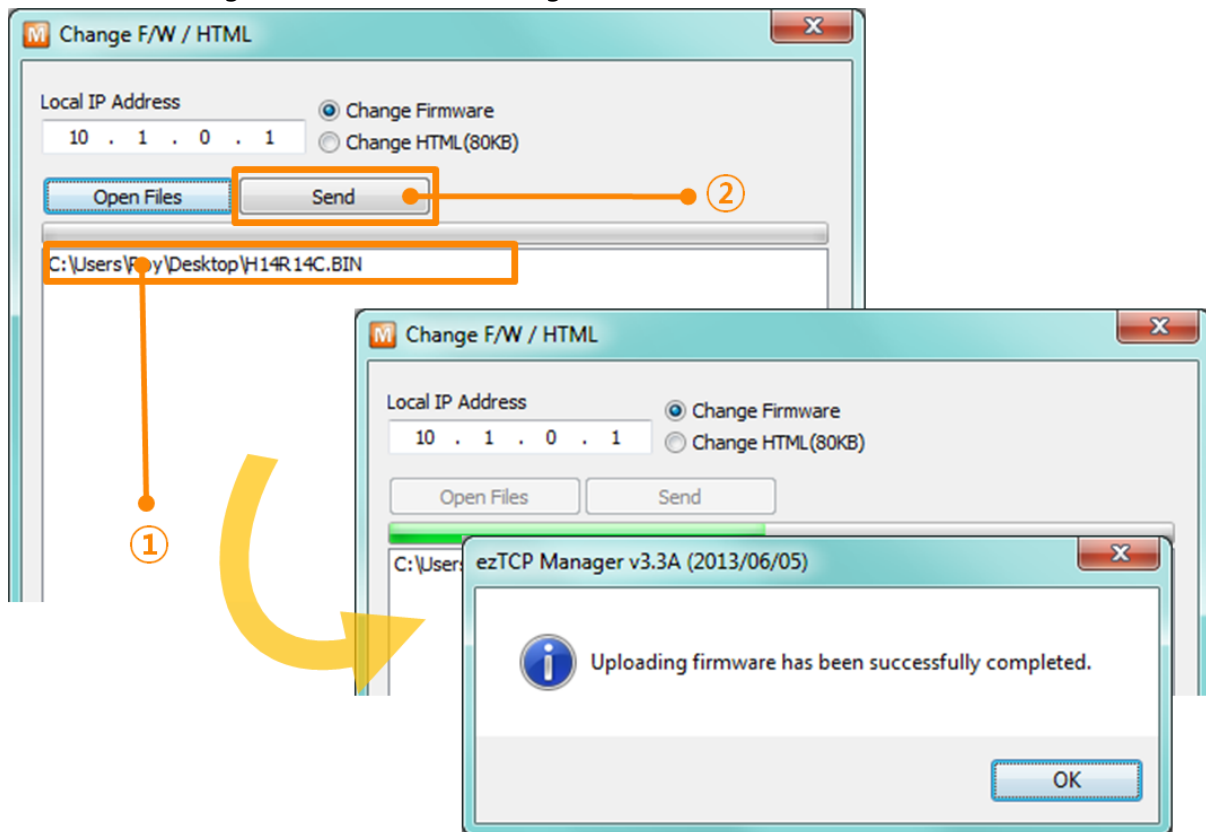

Figure 7-2 sending firmware file

- ① Check if the name and path of the firmware file are correct
- ② Click the [Send] button
- ③ Confirm the completed message

7.2 Changing Webpage

7.2.1 Webpage

CIE-M10 comes preloaded with a webpage to facilitate control and monitoring through HTTP.

7.2.2 Processes

- Making Users' webpage or Downloading sample files
Make your own webpage file or use sample webpage files freely available to download at our web site.
- Entering ISP mode
Enter ISP mode to send HTML files to CIE-M10.
- Writing Web(HTTP) port number and selecting size of Web(HTTP)

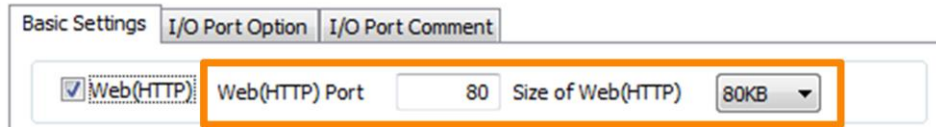

Figure 7-3 Web Basic Settings

☞ **80KB or 96KB for the Size of Web(HTTP) is allowed.**

- Running a TFTP client and ready to send the HTML files
Run a TFTP client program. ezManager is equipped with the client program. Click the [Change F/W / HTML] button.

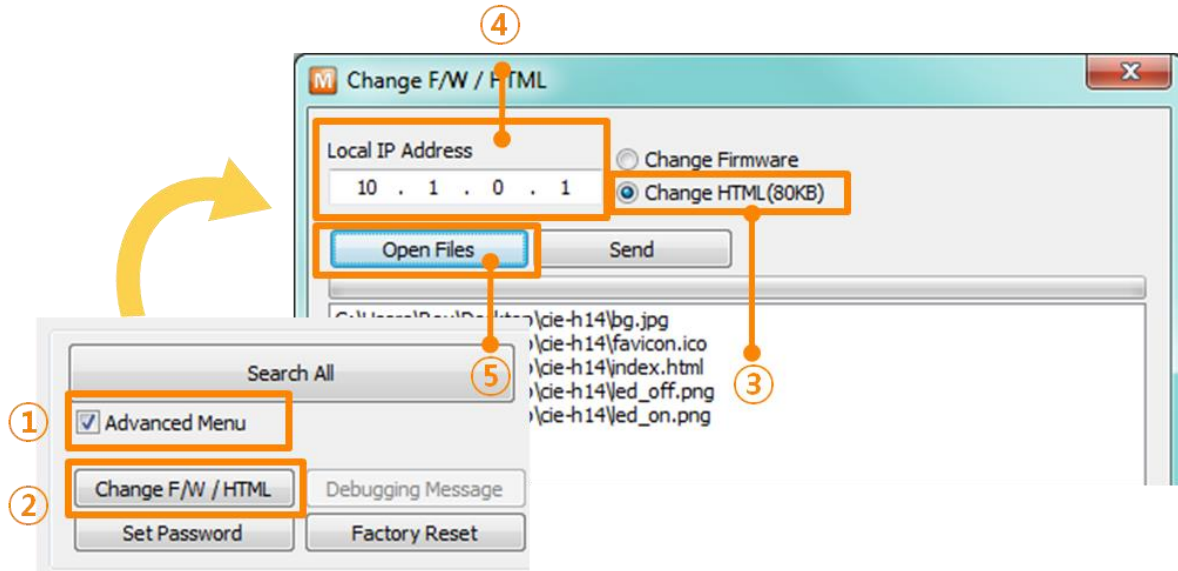

Figure 7-4 running TFTP client

- ① Check the [Advanced Menu] check box
- ② Click the [Change F/W / HTML] button to run TFTP client
- ③ Select the [Change HTML] radio button
- ④ Input the IP address of CIE-M10 to the [Local IP Address] text box
- ⑤ Press the [Open Files] button and choose the HTML file

- Checking files and Sending

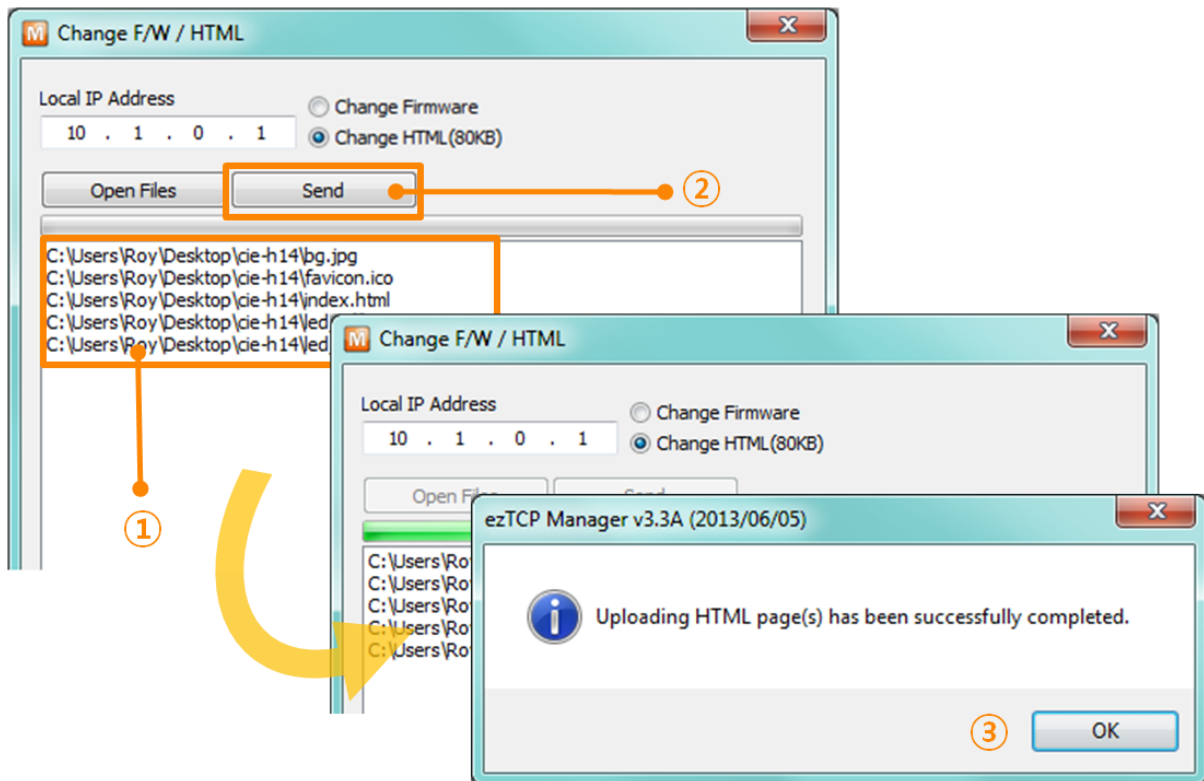

Figure 7-5 sending firmware file

- ① Check if the name and path of the file are correct
- ② Click the [Send] button
- ③ Confirm the completed message

7.3 Status Monitoring

7.3.1 Using TELNET

Once the [TELNET] option is activated, users can remotely log in to CIE-M10. If a password is set, users should input the password.

After that, messages from CIE-M10 appear as shown in the figure below.

☞ Starting with firmware version 2.0A, you can login by entering "sollae" as the default password.

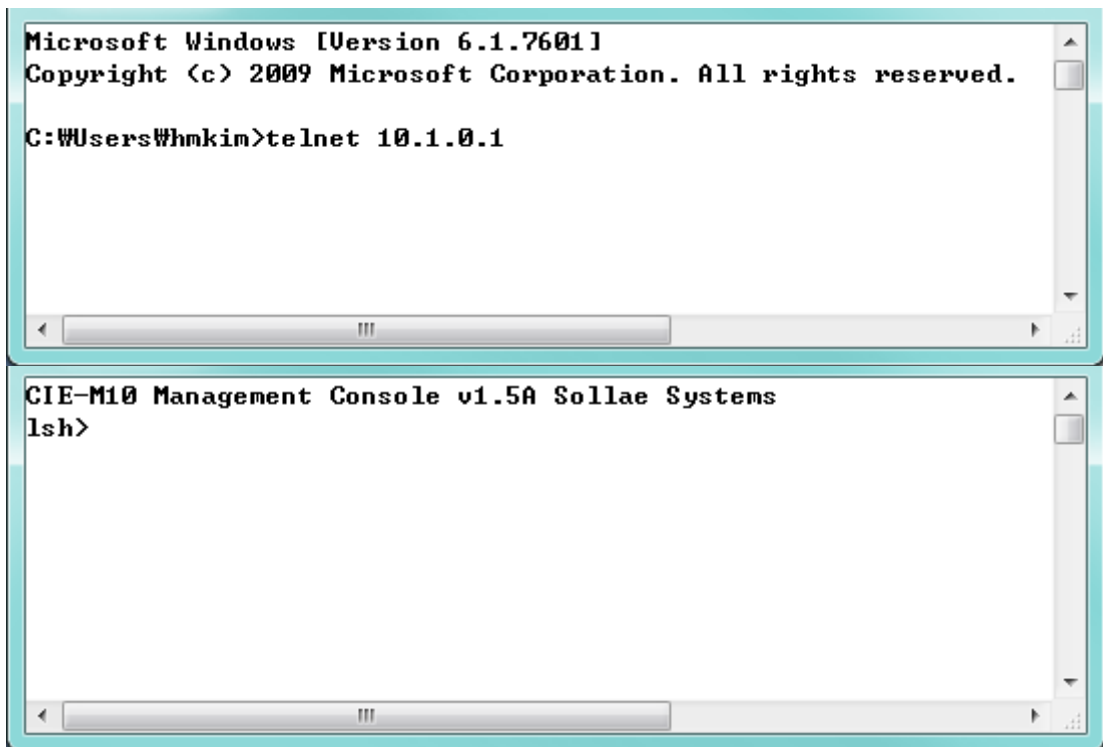

Figure 7-6 log in to CIE-M10 on TELNET

You can check multiple states with the following commands.

command	option	description	usage
st	net	Network Status	lsh>st net
	sio	Serial Port Status	lsh>st sio
	uptime	System Uptime	lsh>st uptime
sc	[OP1][OP2]	Session Control	lsh>sc com1 close
sd	[OP1][OP2]	Capturing Serial Data	lsh>sd 1 100

Table 7-1 commands for checking states

- st net

"st net" command displays present network states of all sessions.

```
lsh>st net
```

proto	name	local address	peer address	sendq	state
TCP	tty	10.1.0.1< 23>	10.7.0.57<50962>	140	ESTABLISHED
TCP	http7	10.1.0.1< 80>	0.0.0.0< 0>	0	LISTEN
TCP	http6	10.1.0.1< 80>	0.0.0.0< 0>	0	LISTEN
TCP	http5	10.1.0.1< 80>	0.0.0.0< 0>	0	LISTEN
TCP	http4	10.1.0.1< 80>	0.0.0.0< 0>	0	LISTEN
TCP	http3	10.1.0.1< 80>	0.0.0.0< 0>	0	LISTEN
TCP	http2	10.1.0.1< 80>	0.0.0.0< 0>	0	LISTEN
TCP	http1	10.1.0.1< 80>	0.0.0.0< 0>	0	LISTEN
TCP	http0	10.1.0.1< 80>	0.0.0.0< 0>	0	LISTEN
TCP	nbus0	10.1.0.1< 502>	0.0.0.0< 0>	0	LISTEN
TCP	com1	0.0.0.0< 1470>	0.0.0.0< 0>	0	LISTEN

Figure 7-7 "st net" command

- st sio

"st sio" command displays the number of bytes for the serial port.

```
lsh>st sio
```

port	fmax	rbmax	rxbuf	txbuf	rx_count	tx_count
com1	0	0	0	0	0	56

Figure 7-8 "st sio" command

- st uptime

"st uptime" command shows amount of time since M10 has booted up.

```
lsh>st uptime
00:23:55.13 up 0 days
```

Figure 7-9 "st uptime" command

- sc

"sc" command is used when users close a session. [OP1] means the name of session, and [OP2] should be "CLOSE".

```
lsh>sc com1 close
com1: closed
```

Figure 7-10 "sc" command

☞ *Lower-case letters are only allowed to use "sc" command.*

- sd

"sd" command is for capturing serial data. [OP1] means name of the session, [OP2] means period, which has a 10ms unit, for the capture.

```
lsh>sd 1 100
com1 dump buffering time : 1000ms
lsh>tx1 => 73 6f 6c 6c 61 65 73 79 73 74 65 6d 73          ! sollaesy stems
tx1 => 74 65 73 74          ! test
```

Figure 7-11 "sd" command

7.3.2 Using ezManager

Status of CIE-M10 can be monitored by [Status] button on ezManager. By using the [Refresh Every 1 Second] option in the status window, the status is automatically updated in every second.

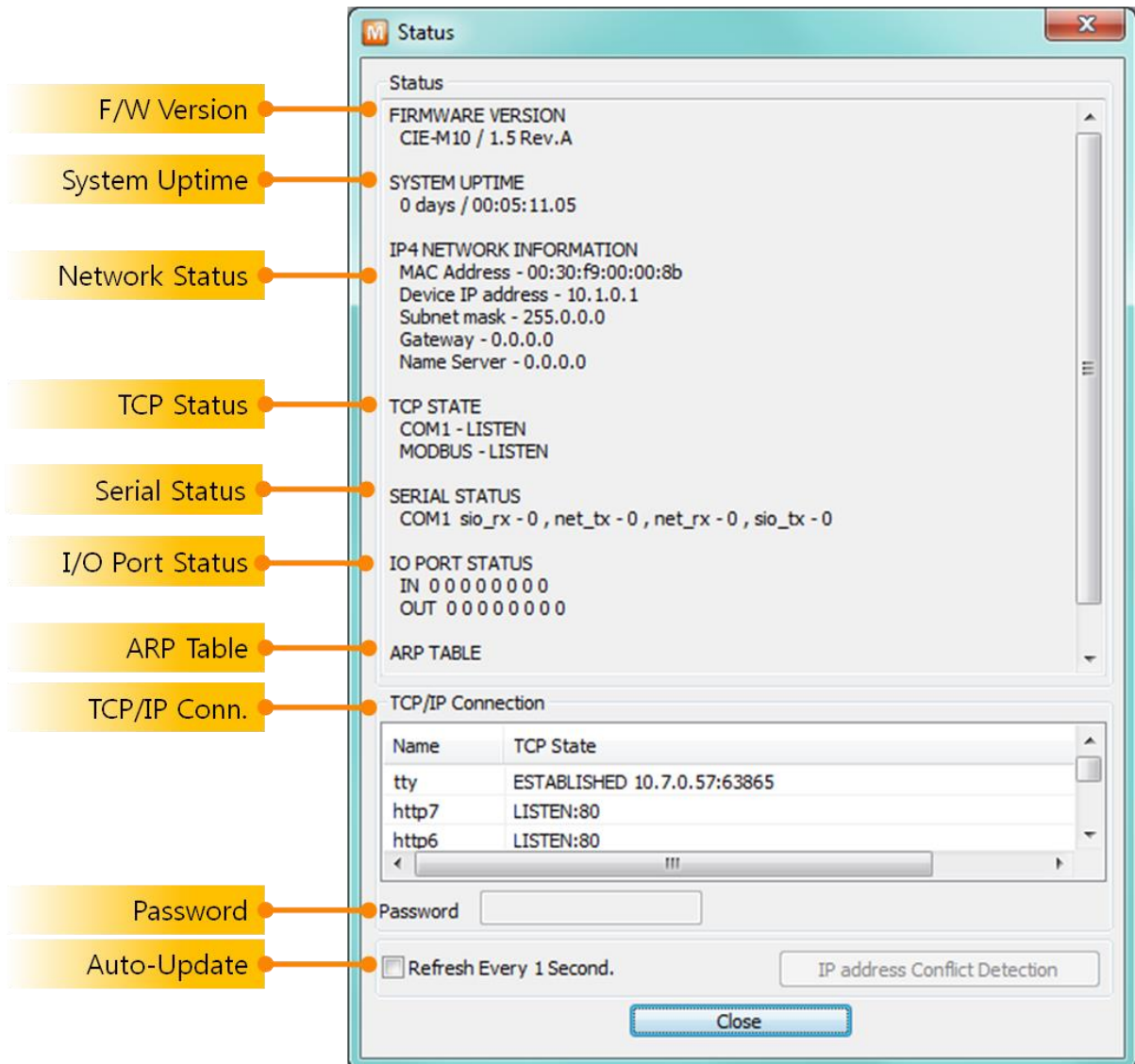

Figure 7-12 status window of ezManager

- **FIRMWARE VERSION**
The name of model and the version of firmware are displayed here.
- **SYSTEM UPTIME**
Operating time of CIE-M10 is displayed since it boots up.
- **IP4 NETWORK INFORMATION**
All information about related items with IP Address including the MAC address is shown here. It works even if the IP address is assigned from DHCP.

- TCP STATE

TCP status of each port is shown in this section.

Message	Description
LISTEN	waiting for requests of a TCP connection
CLOSE	a TCP connection is closed
SYN_SENT	send "SYN" segment to make a TCP connection
ESTABLISHED	When a TCP connection is established
N/A	In UDP mode

Table 7-2 TCP STATE

- SERIAL STATUS

Amount of data in every buffer is displayed. The unit is byte.

Buffer	Description
sio_rx	The number of data which is received from the COM port
net_tx	The number of data which is sent to the remote host
net_rx	The number of data which is received from the remote host
sio_tx	The number of data which is sent to the COM port

Table 7-3 SERIAL STATUS

- I/O PORT STATUS

This represents I/O ports' status. '1' means HIGH(ON) and '0' means LOW(OFF).

- ARP TABLE

This part shows ARP table on CIE-M10. When a TCP connection is established or UDP data communication is performed, the information of IP and MAC address is automatically stored in the ARP table. This information is held for 1 minute. If there is no data communication for 1 minute, the information will be removed.

- TCP/IP Connection

In this section, the same information with TCP STATE is displayed with IP address and port number. A difference is that users can terminate a TCP connection. When right click on a session, a small pop-up window is created.

- Password

This text box is activated when CIE-M10 has a password. If users want to close the TCP connection, this password has to be correctly filled.

- Refresh Every 1 Second.

If this option is checked, ezManager sends query in every second.

8 Additional Functions

8.1 Security

8.1.1 Restriction of Access (ezTCP Firewall)

On the [Option] tab of ezManager, users can set restriction of access function with filtering MAC and IP address.

- Allowed MAC Address

If this option has a value of MAC address, the device which has the MAC address is only permitted to access.

- Allowed IP Address

This is to define hosts with IP address or range of IP address allowed to access. The range is defined by multiplying [IP address] and [Network Mask] in bit unit.

- Examples

IP Address	Network Mask	Allowed IP Address Range
10.1.0.1	255.0.0.0	10.1.0.1 ~ 10.255.255.254
10.1.0.1	255.255.255.0	10.1.0.1 ~ 10.1.0.254
192.168.1.4	255.255.255.255	192.168.1.4

Table 8-1 examples of defining allowed IP range

- Apply to ezManager

[Apply to ezManager] is for applying above two restrictions to ezManager functions like [Search], [Read], [Write], etc.

8.1.2 Setting Password

A password can be used to protect CIE-M10 from TELNET login or changing environmental parameters by hosts who are not designated. The maximum length is 8 bytes of Alphabet or number.

☞ ***When you want to revoke all of these restrictions, change the mode of CIE-M10 to the ISP mode. All restrictions are removable and communication with ezManager is revoked in the ISP mode.***

8.2 Option Tab Functions

8.2.1 Notify IP Change

CIE-M10 can be a TCP server even though it is assigned the IP address automatically. Using [Notify IP Change] function, it sends its IP address with the host name to the specific server. There are 3 types of functions provided: DDNS, TCP and UDP.

- Dynamic Domain Name Service (DDNS)

CIE-M10 supports DDNS function offered by DynDNS to manage its changed IP address as a host name. Therefore, you have to make an account and create host names on the website of DynDNS before use this.

☞ *All about service usage of an account could be changed according to the policy of DynDNS.*

☞ *Homepage of DynDNS: <http://dyn.com/dns/>*

Figure 8-1 setting DDNS

- ① Select the [DDNS (dyndns.org)] item.
- ② 40,320 is a fixed value.
- ③ Input the ID of DDNS account.
- ④ Input the password of the account.
- ⑤ Input one of the host names which you created on your account.

- TCP/UDP

In case you have an own server and want to manage the information about changed IP addresses, you are allowed to use TCP/UDP for using this option. The [Data Type] can be selected as ASCII or hexadecimal, and the [Interval] is available on configuration.

☞ *Refer to the [Notify IP Change] document on our web site for details.*

8.2.2 Sending MAC Address

[Sending MAC Address] is a function that CIE-M10 sends its MAC address to the remote host right after the connection is established. By using this function, a server can identify multiple devices with the information.

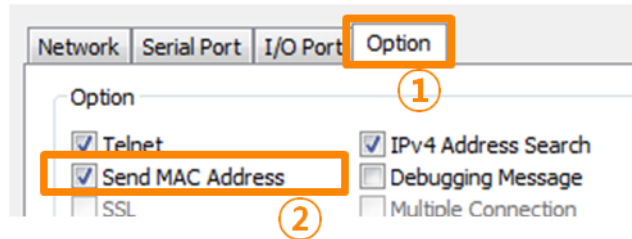

Figure 8-2 setting of Sending MAC Address function

- ① Move to the [Option] tab.
- ② Check the [Send MAC Address] option.

8.2.3 Debugging Message

By using [Debugging] option, users can receive debugging messages from CIE-M10 on the network.

- ☞ ***When you are facing a problem about the TCP connection or data communication, use this function and send us the stored file. We can use it for finding out the reason of your problem.***
- ☞ ***Debugging messages are broadcasted to entire network via UDP so it might cause serious network traffic. Keep in mind that you should turn the option off after using it.***

- Setting debugging option

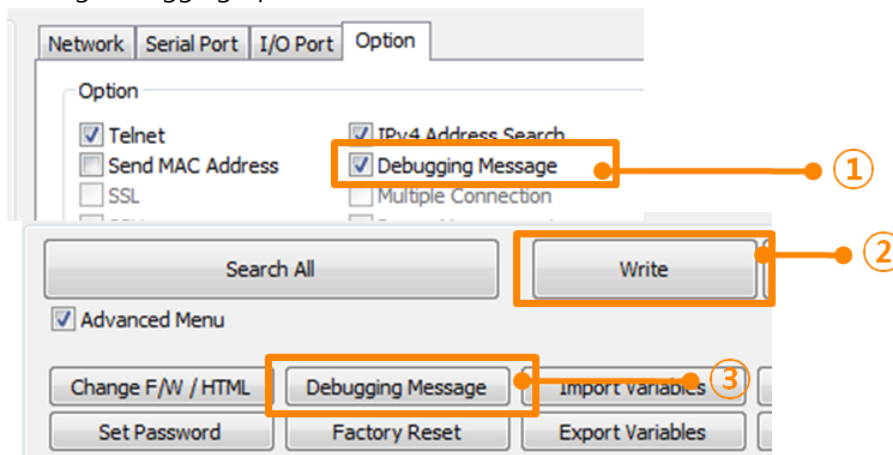

Figure 8-3 setting debugging option

- ① Check the [Debugging Message] option
- ② Press the [Write] button
- ③ After checking the [Advanced Menu], click the [Debugging Message] button. And then, the debugging message window appears on your screen as shown below.

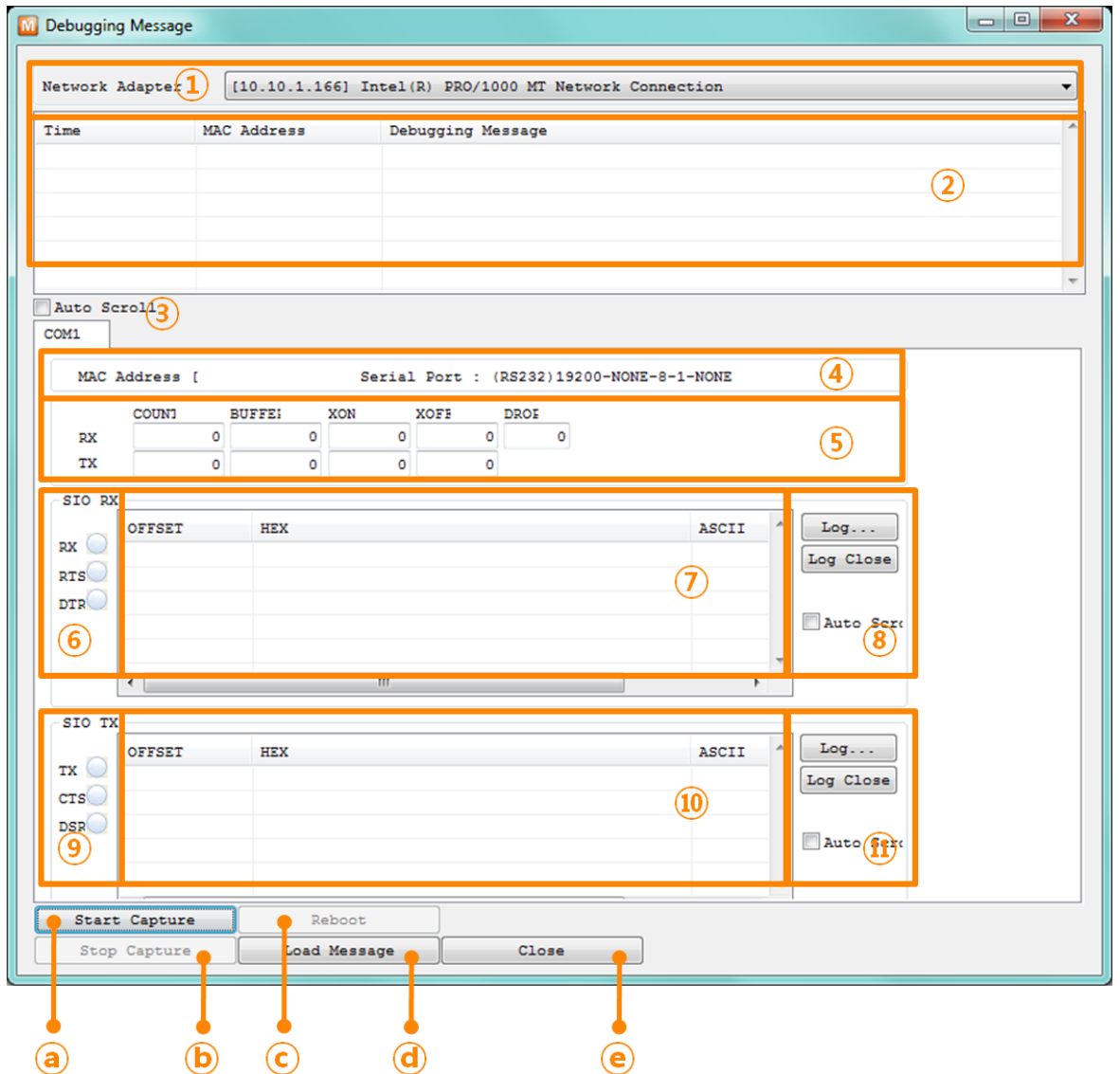

Figure 8-4 debugging message window

- ① Pull down menu for selecting a network adapter
- ② Place for showing received debugging messages from CIE-M10 over the network
- ③ Auto update to display the latest captured file on the screen of ②
- ④ MAC Address Information of a selected message
- ⑤ ~ ⑪ Unavailable
- a To start capturing debugging messages from CIE-M10
- b To stop capturing debugging messages from CIE-M10
- c Unavailable
- d [Load Message] is for loading a debugging log file to display
- e Closing debugging message window

8.3 Serial Port Tab Functions

Figure 8-5 Serial Port Tab

8.3.1 TELNET COM port Control Option (RFC 2217) - ①

This option is for sending and receiving serial port states between two devices. Users can send and receive control signals such as RTS/CTS when the states are changed.

8.3.2 Disable TCP Transmission Delay - ②

If you use this option, CIE-M10 sends the data from the serial port to Ethernet as quickly as possible.

8.3.3 Data Frame Interval - ③

Before sending data from the serial port to Ethernet, ezTCP gathers data in the buffer. If there is no data during the specific time configured in the [Data Frame Interval], ezTCP will send data to the network. In case the value is set to 0, data will be sent immediately.

☞ Please set this value to 11 or higher values for correct operation.

8.3.4 TX interval - ④

This option is for preventing data loss in the case that the serial device has very small buffer size or does not have a buffer. The range of the value could be from 0 to 25 and the unit is duration of sending 1 byte. For example, if you set this value to 5, each byte will be transferred with duration of sending 5 bytes.

8.3.5 TCP Server / Client mode - ⑤

This mode is available on TCP client mode only. In this mode, you do not need to change the mode for switching active or passive TCP connection. Note that the [Event Byte] option should be set to 1 or larger value.

8.3.6 Separator - ⑥

Using this function, you can control the length of network packets by specific characters. When you enable this function, the maximum packet size is 512 bytes.

separator	options
Length	select the length between 0 ~ 4 bytes
Operation	Transmit Separators without additional bytes
	Transmit Separators + 1 byte
	Transmit Separators + 2 bytes

Table 8-2 separator

 ***If you want to get more information about the above functions, refer to the technical documents on the [Download] >> [Technical documents] page at our web site.***

8.4 I/O Port Tab Functions

8.4.1 Notify Input Port Change

When a CIE-M10 operates as a Modbus/TCP slave and this function is enable, if status of input ports are changed, CIE-M10 immediately sends the master response packets to Modbus/TCP masters regardless of master's query.

8.4.2 Valid Time

CIE-M10 only recognizes signals of the input ports as the valid signals when the signal lasts for the [Valid Time]. If the signals are not maintained for the [Valid Time], the input signals will be ignored. The unit used for the [Valid Time] is 1ms. However, because the accuracy is only guaranteed in 10ms, the designated values are rounded down in units of 10ms.

8.4.3 Delay

Output values are reflected to CIE-M10's output ports later than the time set to [Delay]. For example, if [Delay] is set to '0', the output values are reflected to the output ports immediately. Although it is allowed to set the values in 1ms, it is accurate to 10ms, rounded down.)

☞ ***If the timer for the [Delay] is already running, all the subsequent orders for giving signals to the output ports are ignored.***

9 Self-Test in Trouble

When users are in trouble with using CIE-M10, make sure of the following steps first.

9.1 Searching problem with ezManager

- Confirming types of configuration utility
CIE-M10 can be configured by ezManager.
- Cancelling the Firewall operation
In case of being blocked by firewalls of a personal computer or network block, you must cancel all the firewalls before searching CIE-M10.

☞ ***Most of vaccine programs have firewall functions so it can cause some trouble to search CIE-M10. Close or pause these programs before searching the product.***

- Stable supply of the power
Check if the power is supplied continually. The red LED on the CIE-M10 shows that the power is switched on.
- Connection with the network
Make sure that the network connection is fine including Ethernet cable. In this step, we recommend that users connect CIE-M10 with PC directly or in the same network hub.
- Checking options of restriction
In case that restriction of access is activated, the communication with ezManager will be unavailable. When users are in this situation, make CIE-M10 operate in ISP mode.

9.2 Connection Problem over Modbus/TCP

- Checking parameters related with TCP/IP

When CIE-M10 has a private network IP address, personal computer's IP address has to be on the same sub network. Check if the IP address and local port number are correct. In case of a fixed IP address, the subnet mask, gateway IP address and DNS IP address should be configured.

Slave or Master
Local IP Address, the connection mode (Active / Passive), Peer Address and Peer Port, Subnet Mask, Gateway IP Address, DNS IP Address, DDNS option and etc.

Table 9-1 major parameters related with Modbus/TCP

- PING Test

Confirm the connection over the network by PING test. If CIE-M10 does not send any reply from the request, check the network environment.

- Firewall

In case the networks which need strong security, the access may be denied by their firewall. Under this circumstance, users should ask the person in charge of their network to release ports which will be used. (Ex: TCP 502, UDP 50005)

- Operation Mode

A TCP connection is not possible when CIE-M10 is operating in the ISP or Serial Configuration mode.

- Connection Mode

To make a TCP connection, both a server (passive mode) and a client (active mode) should exist. If there are only servers or clients, the TCP connection cannot be established.

- ezTCP Firewall

When users set the ezTCP firewall with MAC and IP address, any hosts cannot be reachable to it except for the hosts who have the allowed MAC and IP address. Inactivate the option or check the setting is correct.

- Checking the TCP status

TCP is a protocol connected one to one without multiple connections function. Because of this, if a device is on a TCP connection, other requests are denied. If users are in this situation, check the network status by connecting on TELNET or using ezManager.

9.3 Communication Problem over Modbus/TCP

- Checking Modbus/TCP parameters
Check all the related parameters that [Unit ID], [Input Port Base Address], [Output Port Base Address], [Poll Interval] and [Notify Input change].
- Checking which mode is using
In case of MACRO or serialized Modbus/TCP, you can control the outputs of CIE-M10. Turn the mode off if those modes are using.

☞ *Contact us if you have any questions about above steps or our products.*

10 Related material

10.1 Technical Documents

You can find the following technical documents at our website.

- Datasheet
- Modbus/TCP protocol
- Internet switch
- Combinations of I/O Controllers
- Digital Pulse Output
- IP Change Notification (DDNS)
- Sending MAC Address function
- TCP Server/Client mode
- Telnet COM Port Control Option
- Modmap Users' manual
- etc

10.2 Smart phone application

- ezManager (iOS)
- ezManager (Android)
- TCP/IP Client (Android)

11 Technical Support and Warranty

11.1 Technical Support

If you have any question regarding operation of the product, visit Customer Support FAQ corner and the message board on Sollae Systems' web site or send us an email at the following address:

- E-mail: support@eztcp.com
- Website Address for Customer Support: <http://www.eztcp.com/en/support/>

11.2 Warranty

11.2.1 Refund

Upon the customer's request to refund the product within two weeks after purchase, Sollae Systems will refund the product.

11.2.2 Free Repair Services

For product failures occurring within two years after purchase, Sollae Systems provides free repair services or exchange the product. However, if the product failure is due to user's fault, repair service fees will be charged or the product will be replaced at user's expense.

11.2.3 Charged Repair Services

For product failures occurring after the warranty period (two years) or resulting from user's fault, repair service fees will be charged and the product will be replaced at user's expense.

12 Precaution and Exemption from Liability

12.1 Precaution

- Sollae Systems is not responsible for product failures occurring due to user's alteration of the product.
- Specifications of the product are subject to change without prior notice for performance improvement.
- Sollae Systems does not guarantee successful operation of the product if the product was used under conditions deviating from the product specifications.
- Reverse engineering of firmware and applications provided by Sollae Systems is prohibited.
- Use of firmware and applications provided by Sollae Systems for purposes other than those for which they were designed is prohibited.
- Do not use the product in an extremely cold or hot place or in a place where vibration is severe.
- Do not use the product in an environment in which humidity is high or a lot of oil exists.
- Do not use the product where there is caustic or combustible gas.
- Sollae Systems does not guarantee normal operation of the product under the conditions a lot of noise exists.
- Do not use the product for a purpose that requires exceptional quality and reliability relating to user's injuries or accidents – aerospace, aviation, health care, nuclear power, transportation, and safety purposes.
- Sollae Systems is not responsible for any accident or damage occurring while using the product.

12.2 Exemption from Liability

12.2.1 English version

In no event shall Sollae Systems Co., Ltd. and its distributors be liable for any damages whatsoever (including, without limitation, damages for loss of profit, operating cost for commercial interruption, loss of information, or any other financial loss) from the use or inability to use the CIE-M10 even if Sollae Systems Co., Ltd. or its distributors have been informed of such damages.

The CIE-M10 is not designed and not authorized for use in military applications, in nuclear applications, in airport applications or for use in applications involving explosives, or in medical applications, or for use in security alarm, or for use in a fire alarm, or in applications involving elevators, or in embedded applications in vehicles such as but not limited to cars, planes, trucks, boats, aircraft, helicopters, etc..

In the same way, the CIE-M10 is not designed, or intended, or authorized to test, develop, or be built into applications where failure could create a dangerous situation that may result in financial losses, damage to property, personal injury, or the death of people or animals. If you use the CIE-M10 voluntarily or involuntarily for such unauthorized applications, you agree to subtract Sollae Systems Co., Ltd. and its distributors from all liability for any claim for compensation.

Sollae Systems Co., Ltd. and its distributors entire liability and your exclusive remedy shall be Sollae Systems Co., Ltd. and its distributors option for the return of the price paid for, or repair, or replacement of the CIE-M10.

Sollae Systems Co., Ltd. and its distributors disclaim all other warranties, either expressed or implied, including, but not limited to, the implied warranties of merchantability and fitness for a particular purpose, with respect to the CIE-M10 including accompanying written material, hardware and firmware.

12.2.2 French version

- Documentation

La documentation du CIE-M10 est conçue avec la plus grande attention. Tous les efforts ont été mis en œuvre pour éviter les anomalies. Toutefois, nous ne pouvons garantir que cette documentation soit à 100% exempt de toute erreur. Les informations présentes dans cette documentation sont données à titre indicatif. Les caractéristiques techniques peuvent changer à tout moment sans aucun préavis dans le but d'améliorer la qualité et les

possibilités des produits.

- Copyright et appellations commerciales

Toutes les marques, les procédés, les références et les appellations commerciales des produits cités dans la documentation appartiennent à leur propriétaire et Fabricant respectif.

- Conditions d'utilisations et limite de responsabilité

En aucun cas Sollae Systems Co., Ltd. ou un de ses distributeurs ne pourra être tenu responsable de dommages quels qu'ils soient (intégrant, mais sans limitation, les dommages pour perte de bénéfice commercial, interruption d'exploitation commerciale, perte d'informations et de données à caractère commercial ou de toute autre perte financière) provenant de l'utilisation ou de l'incapacité à pouvoir utiliser le CIE-M10, même si Sollae Systems Co., Ltd. ou un de ses distributeurs a été informé de la possibilité de tels dommages.

Le CIE-M10 est exclusivement prévu pour un usage en intérieur, dans un environnement sec, tempéré (+10 °C à +40°C) et non poussiéreux. Le CIE-M10 n'est pas prévu, ni autorisé pour être utilisé en extérieur, ni de façon embarquée dans des engins mobiles de quelque nature que ce soit (voiture, camion, train, avion, etc...), ni en milieu explosif, ni dans des enceintes nucléaires, ni dans des ascenseurs, ni dans des aéroports, ni dans des enceintes hospitaliers, ni pour des applications à caractère médical, ni dans des dispositifs de détection et d'alerte anti-intrusion, ni dans des dispositifs de détection et d'alerte anti-incendie, ni dans des dispositifs d'alarme GTC, ni pour des applications militaires.

De même, le CIE-M10 n'est pas conçu, ni destiné, ni autorisé pour expérimenter, développer ou être intégré au sein d'applications dans lesquelles une défaillance de celui-ci pourrait créer une situation dangereuse pouvant entraîner des pertes financières, des dégâts matériel, des blessures corporelles ou la mort de personnes ou d'animaux. Si vous utilisez le CIE-M10 volontairement ou involontairement pour de telles applications non autorisées, vous vous engagez à soustraire Sollae Systems Co., Ltd. et ses distributeurs de toute responsabilité et de toute demande de dédommagement.

En cas de litige, l'entière responsabilité de Sollae Systems Co., Ltd. et de ses distributeurs vis-à-vis de votre recours durant la période de garantie se limitera exclusivement selon le choix de Sollae Systems Co., Ltd. et de ses distributeurs au remboursement de votre produit ou de sa réparation ou de son échange. Sollae Systems Co., Ltd. et ses distributeurs démentent toutes autres garanties, exprimées ou implicites.

Tous les CIE-M10 sont testés avant expédition. Toute utilisation en dehors des spécifications et limites indiquées dans cette documentation ainsi que les court-circuit, les chocs, les utilisations non autorisées, pourront affecter la fiabilité, créer des dysfonctionnements et/ou la destruction du CIE-M10 sans que la responsabilité de Sollae Systems Co., Ltd. et de ses distributeurs ne puissent être mise en cause, ni que le CIE-M10 puisse être échangé au titre de la garantie.

- Rappel sur l'évacuation des équipements électroniques usagés

Le symbole de la poubelle barré présent sur le CIE-M10 indique que vous ne pouvez pas vous débarrasser de ce dernier de la même façon que vos déchets courants. Au contraire, vous êtes responsable de l'évacuation du CIE-M10 lorsqu'il arrive en fin de vie (ou qu'il est hors d'usage) et à cet effet, vous êtes tenu de le remettre à un point de collecte agréé pour le recyclage des équipements électriques et électroniques usagés. Le tri, l'évacuation et le recyclage séparés de vos équipements usagés permettent de préserver les ressources naturelles et de s'assurer que ces équipements sont recyclés dans le respect de la santé humaine et de l'environnement. Pour plus d'informations sur les lieux de collecte des équipements électroniques usagés, contacter votre mairie ou votre service local de traitement des déchets.

13 Revision History

Date	Version	Comment	Author
2009.06.24.	1.0	○ Initial Release	
2009.07.01	1.1	○ Add a notification about being removed JP2	
2011.08.09	2.0	○ Document style has been changed based on CIE-M10's manual v2.6 ○ Dimension of top and side view has been added	Roy LEE
2011.12.14	2.1	○ Descriptions of DynDNS service has been changed. ○ Descriptions of FIFO function has been deleted.	Amy Kim
2012.02.08	2.2	○ Add recommended values of the Event Byte ○ Download link and Typo have been fixed.	Amy Kim
2012.05.23	2.3	○ Modify Icons ○ Extend the warranty period to two years	Amy Kim
2012.06.25	2.4	○ Change description of network interface ○ Remove description about PPPoE and DHCP	Amy Kim
2012.10.08	2.5	○ Fixed Digital Input Ports Interface Circuit Error (Buffer -> Inverter)	Matthew Lee
2013.02.21	2.6	○ Add description of reset time ○ Modify some document styles	Amy Kim
2013.05.09	2.7	○ Add related material ○ Add Exemption From Liability	Amy Kim
2013.05.16	2.8	○ Add Exemption From Liability (French version) ○ Add Feature	Amy Kim
2013.08.21	2.9	○ Add the function of Pulse Control through WEB ○ Modify the screen capture images to new version.	Amy Kim
2013.12.26	3.0	○ Correct some errors and expressions	Amy Kim
2016.03.24	3.1	○ Add explanation for telnet login.	Jack Kim
2016.08.31	3.2	○ Add a description on 8.3.6. Separator ○ Add a description on 8.4.1. Notify Input Port Change	Sara Lee